

# SOJAG

produits saisonniers • seasonal products

Sojag code : 999-8162950

CUP/UPC code : 772830162950

QUESTIONS? 1 866-901-1649

## Assembly Manual / Guide d'assemblage / Manual de ensamblaje / 조립설명서 / Montageanleitung

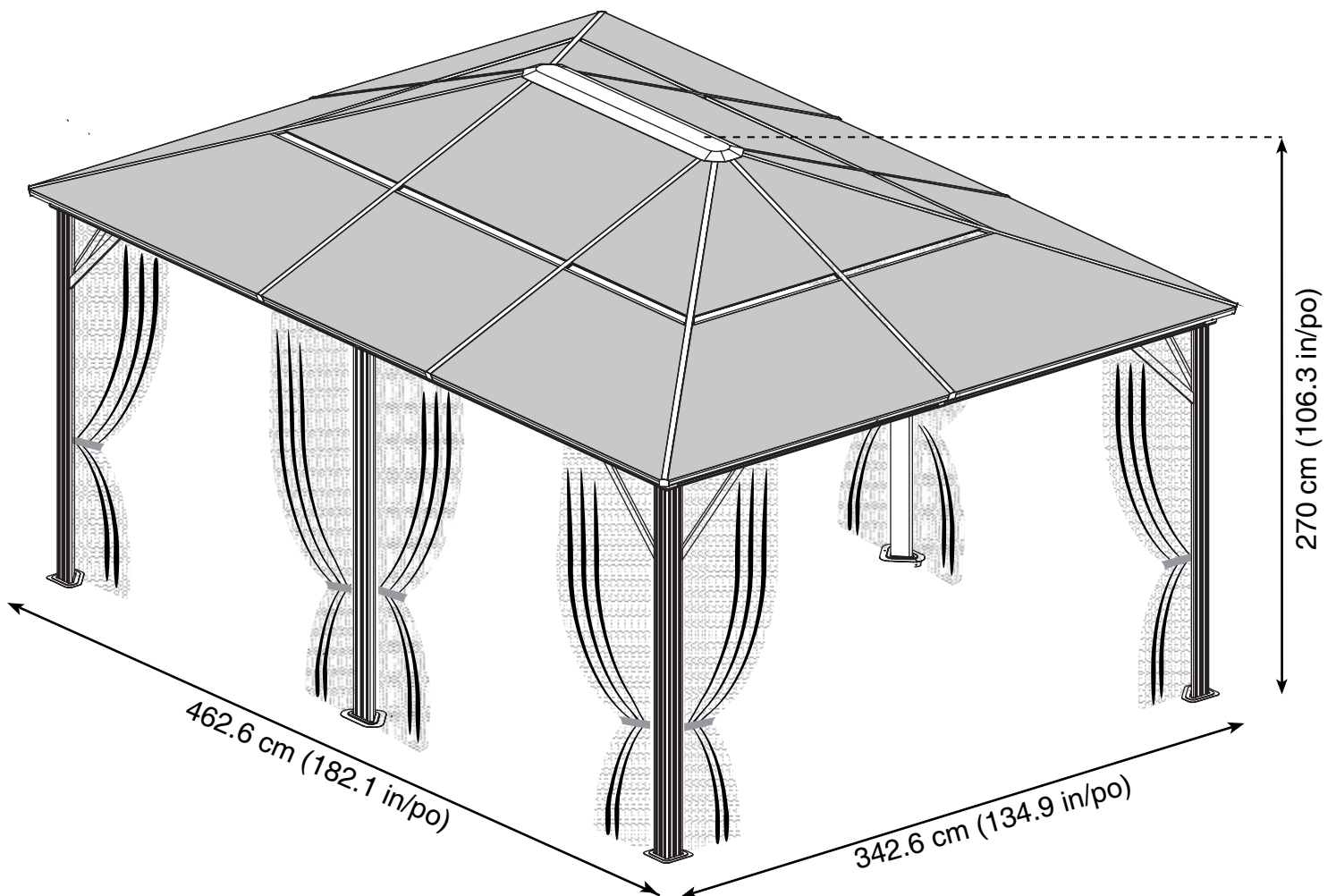

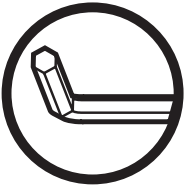

Use the hex keys in the box. / Utilisez les clés hexagonales fournies dans la boîte. /  
Utilice las llaves hexagonales en la caja. / 상자에 육각 키를 사용 하십시오. / Verwenden Sie  
die Sechskantschlüssel in der Box.

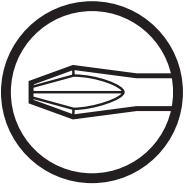

Please use a Phillips screwdriver. / Utilisez un tournevis de type Phillips / Por favor,  
use un destornillador Phillips. / 십자 드라이버를 사용 하십시오. / Bitte verwenden  
Sie einen Kreuzschraubenzieher.



You may need to use a drill for this step. / Vous pouvez avoir besoin d'utiliser une  
perceuse pour cette étape. / Puede que tenga que utilizar un taladro para este paso. /  
이 단계에선 드릴을 사용해야 할 수도 있습니다. / Für diesen Schritt können Sie einen  
Bohrer verwenden.



Wearing protective gloves is recommended. / Le port de gants de protection est recommandé /  
El uso de guantes de protección se recomienda. / 보호 장갑을 착용 하는 것이 좋습니다. /  
Das Tragen von Schutzhandschuhen wird empfohlen.



Two or more people are required at this stage. / Deux personnes ou plus sont nécessaires à cette  
étape. / Dos o más personas se requieren en esta etapa. / 이 단계에서는 두 명 이상 이 필요합니다. /  
Für diesen Bauschritt sind 2 oder mehr Personen erforderlich.



Do not tighten screws all the way for now. / Ne pas visser fermement pour l'instant. /  
No atornille con firmeza por ahora. / 아직 나사를 단단히 조이지 마십시오. / Bitte die  
Schrauben zum jetzigen Zeitpunkt noch nicht fest anziehen.



Sold separately. / Vendus séparément. / vendido en las opciones. /  
옵션 판매 / Optional erhältlich

**U** X68(+6)

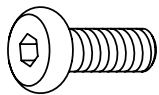

**U1** X 52 (+5)

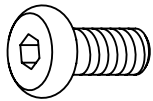

**U2** X2 (+1)



**V** X 16 (+3)

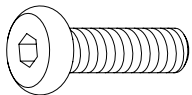

**V1** X1 (+1)

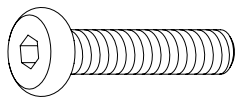

**W** X 16 (+2)

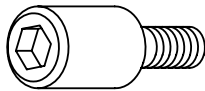

**X** X 10 (+2)

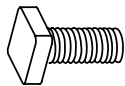

**X1** X 30 (+6)



**Y** X 24 (+4)

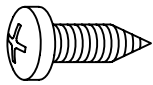

**Y1** X 20 (+4)

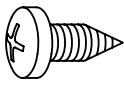

**Z** X1

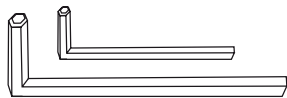

**Z1** X2

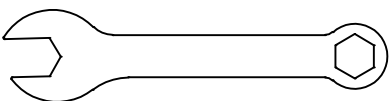



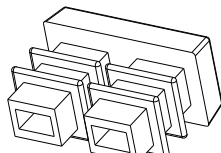





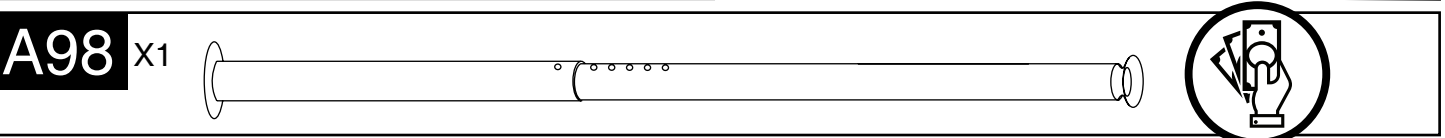
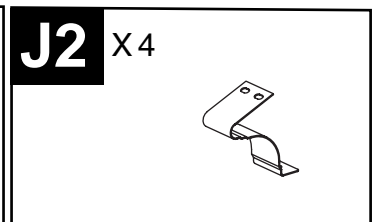
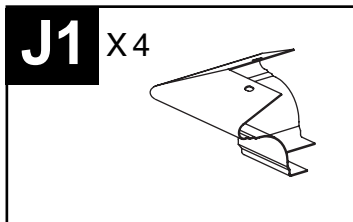
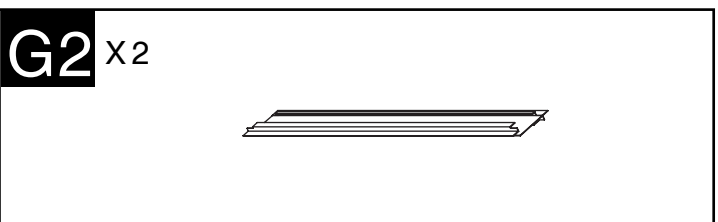
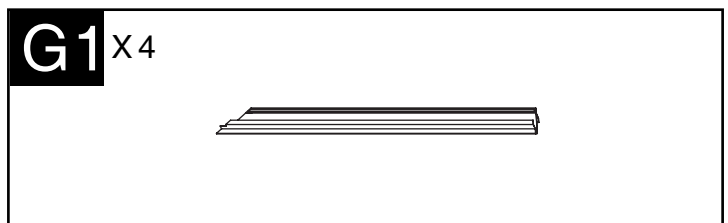
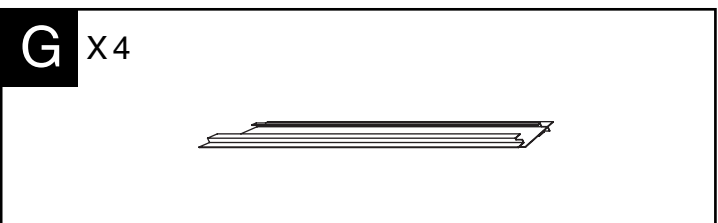
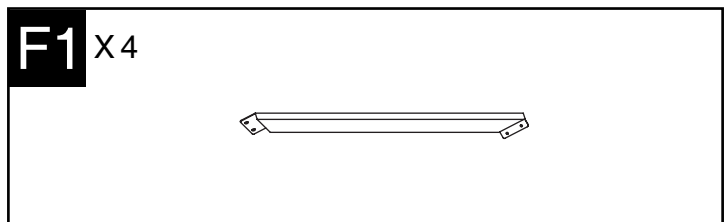
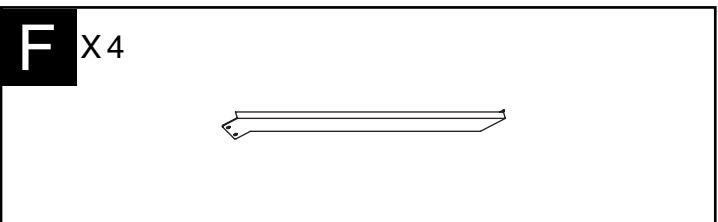
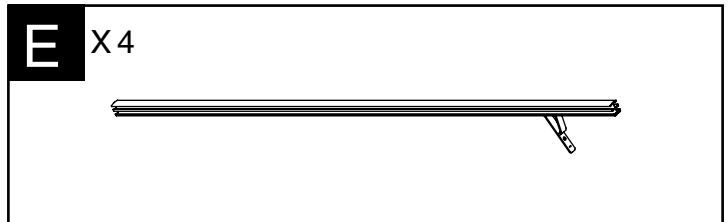
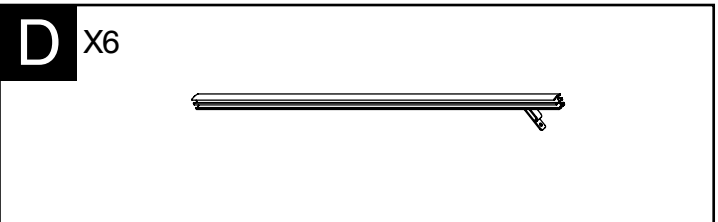
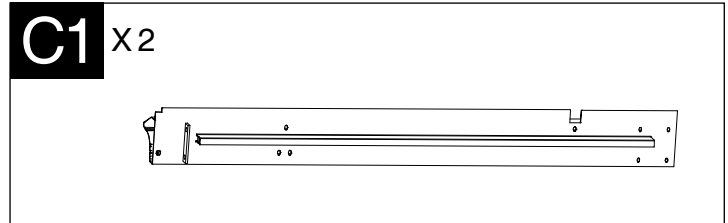
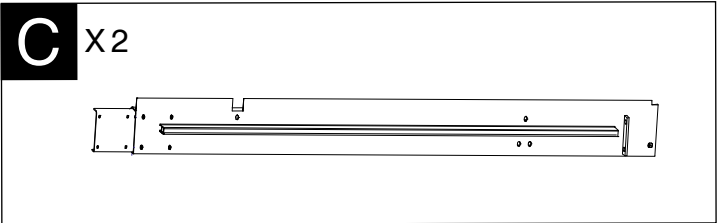
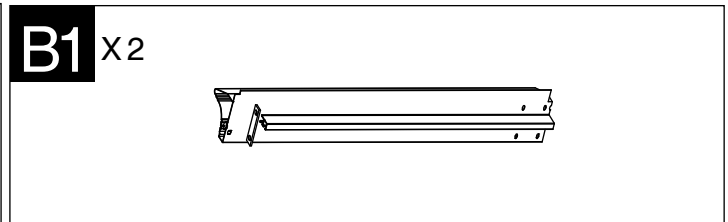
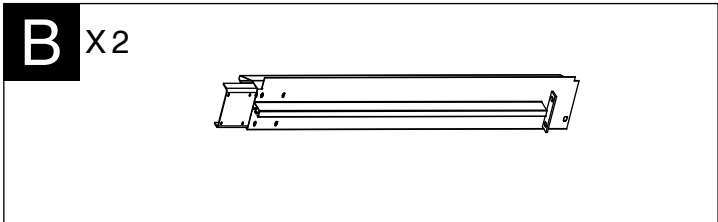
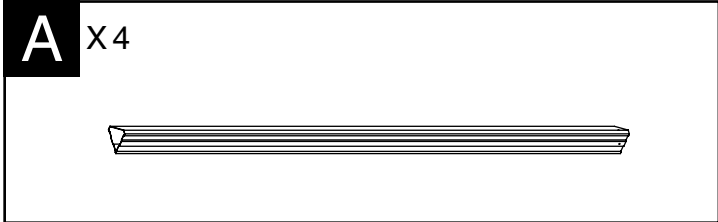







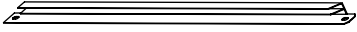
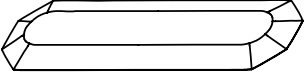
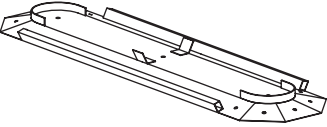
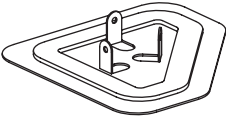
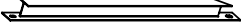
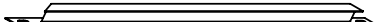
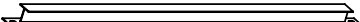

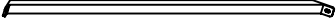
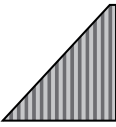
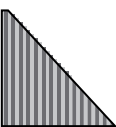
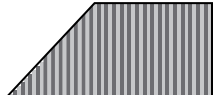
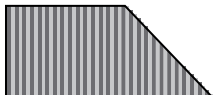
**Z2** X4(+1)

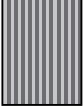

**Z3** X8(+2)

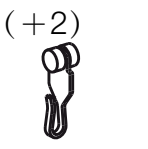
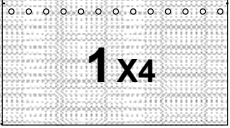
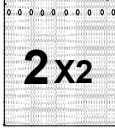

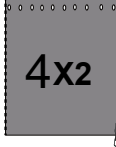

<b>H</b> X4 	<b>H1</b> X4 	<b>H2</b> X2 
<b>I</b> X4 	<b>I1</b> X4 	<b>I2</b> X2 
<b>K</b> X1 	<b>K1</b> X1 	<b>L</b> X6 
<b>N</b> X4 	<b>N1</b> X4 	
<b>N2</b> X2 	<b>O</b> X4 	<b>O1</b> X6 
<b>Q</b> X4 	<b>Ma</b> X4 	<b>M1a</b> X4 
<b>Mb</b> X4 	<b>M1b</b> X4 	
<b>P</b> X2 	<b>P1</b> X2 	<b>T</b> X 68 (+2) Optional  
		<b>T</b> X 68 (+2) Optional  
<b>Net</b>  <b>1x4</b>  <b>2x2</b>  Optional	<b>Curtain</b>  <b>3x4</b>  <b>4x2</b>  Optional	

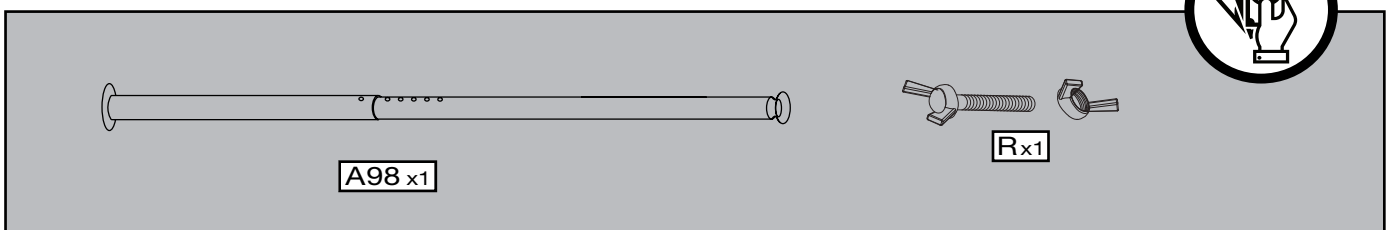
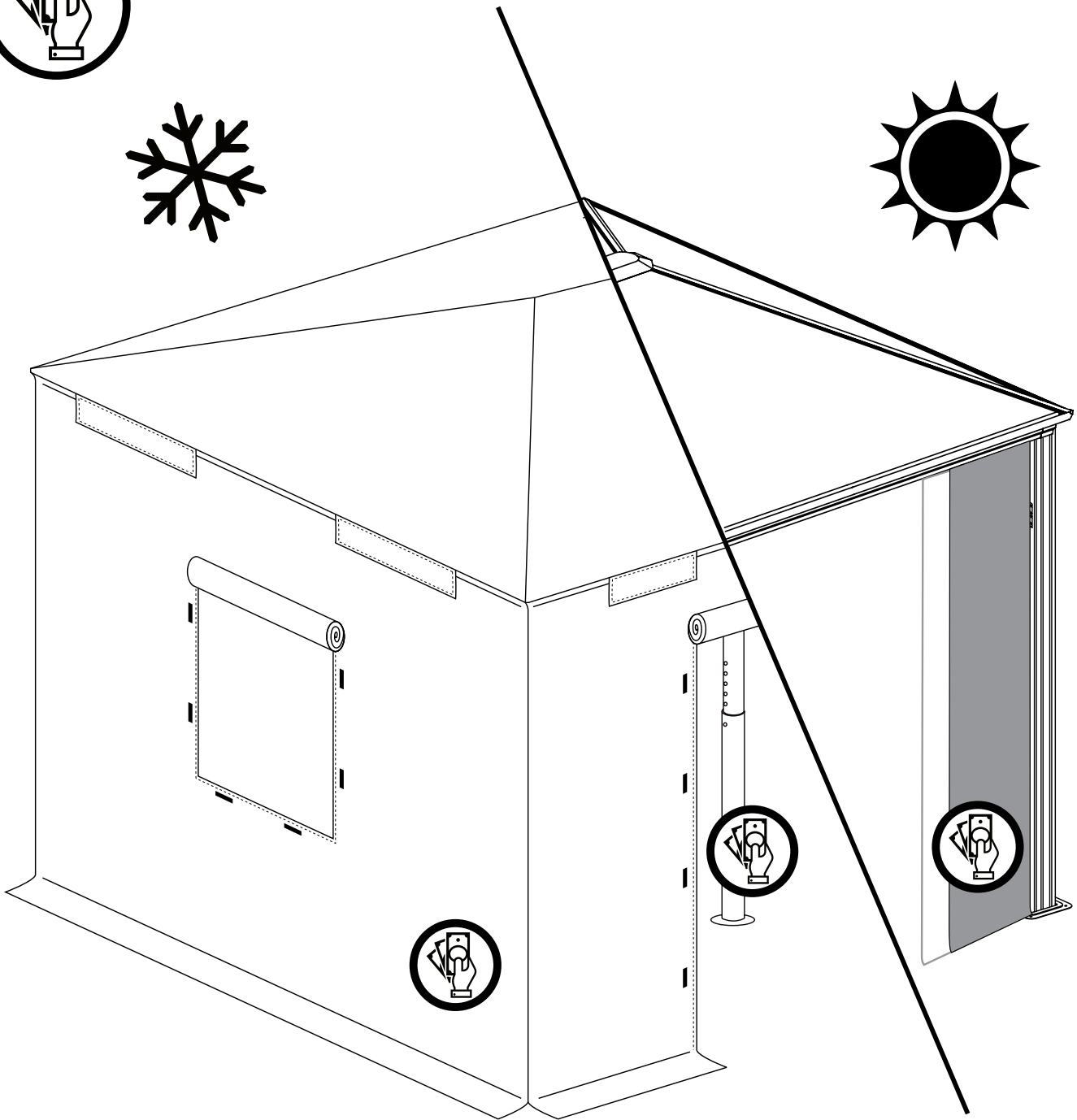
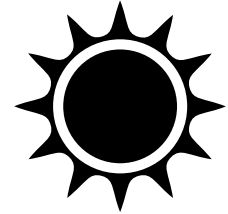
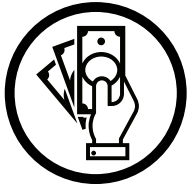

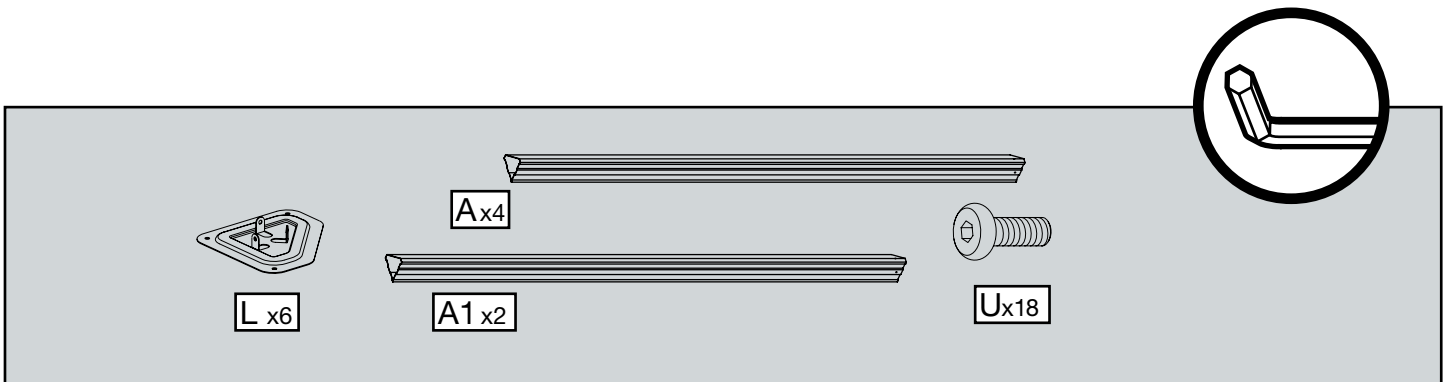
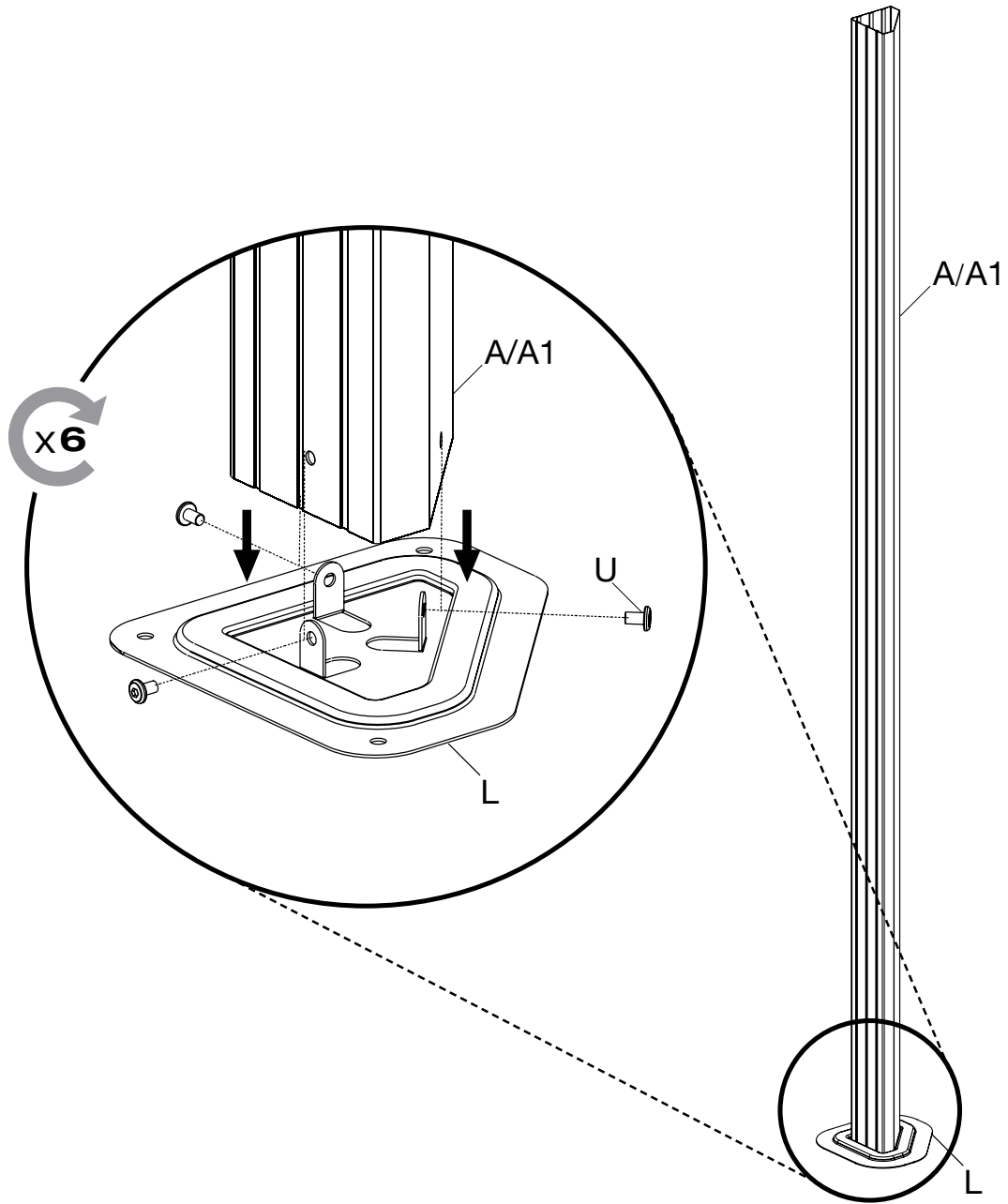

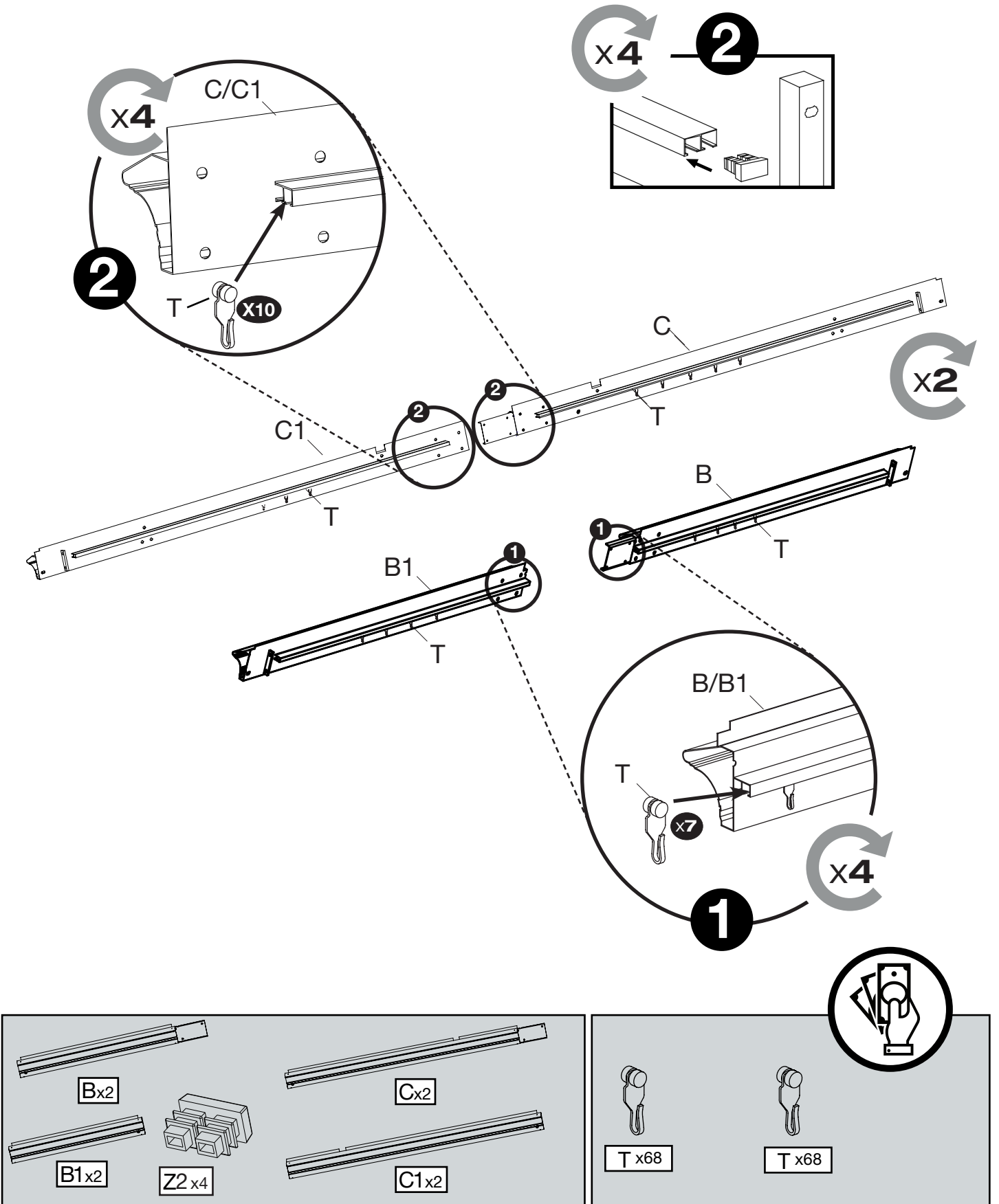



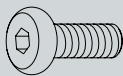
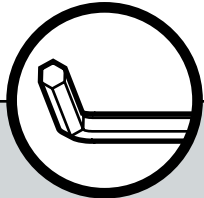
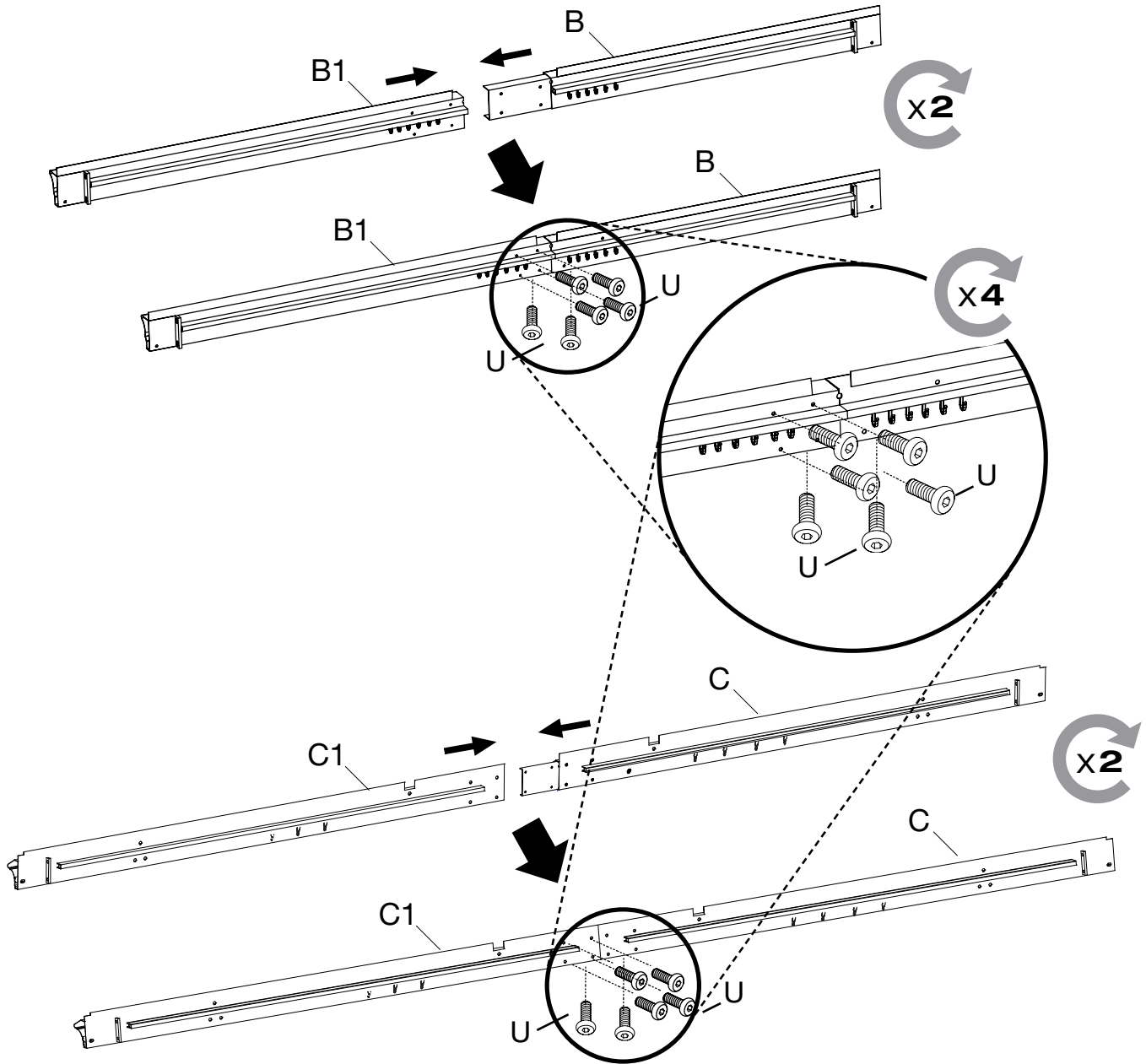

Ux24

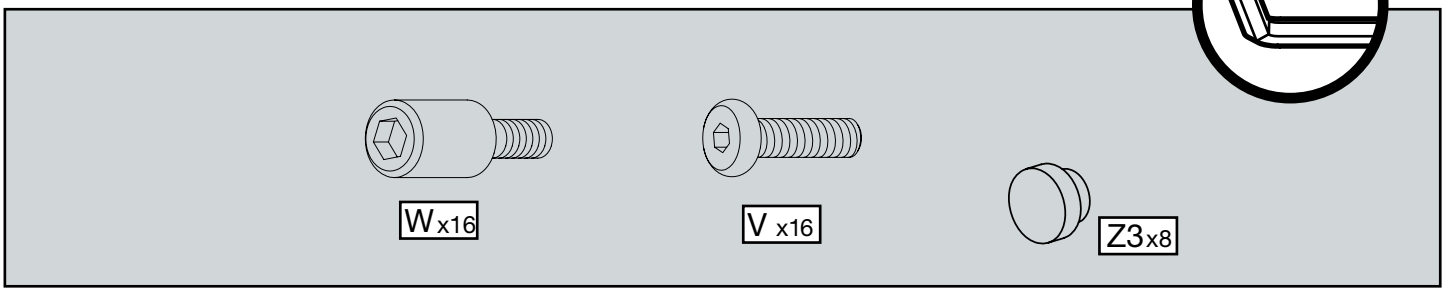
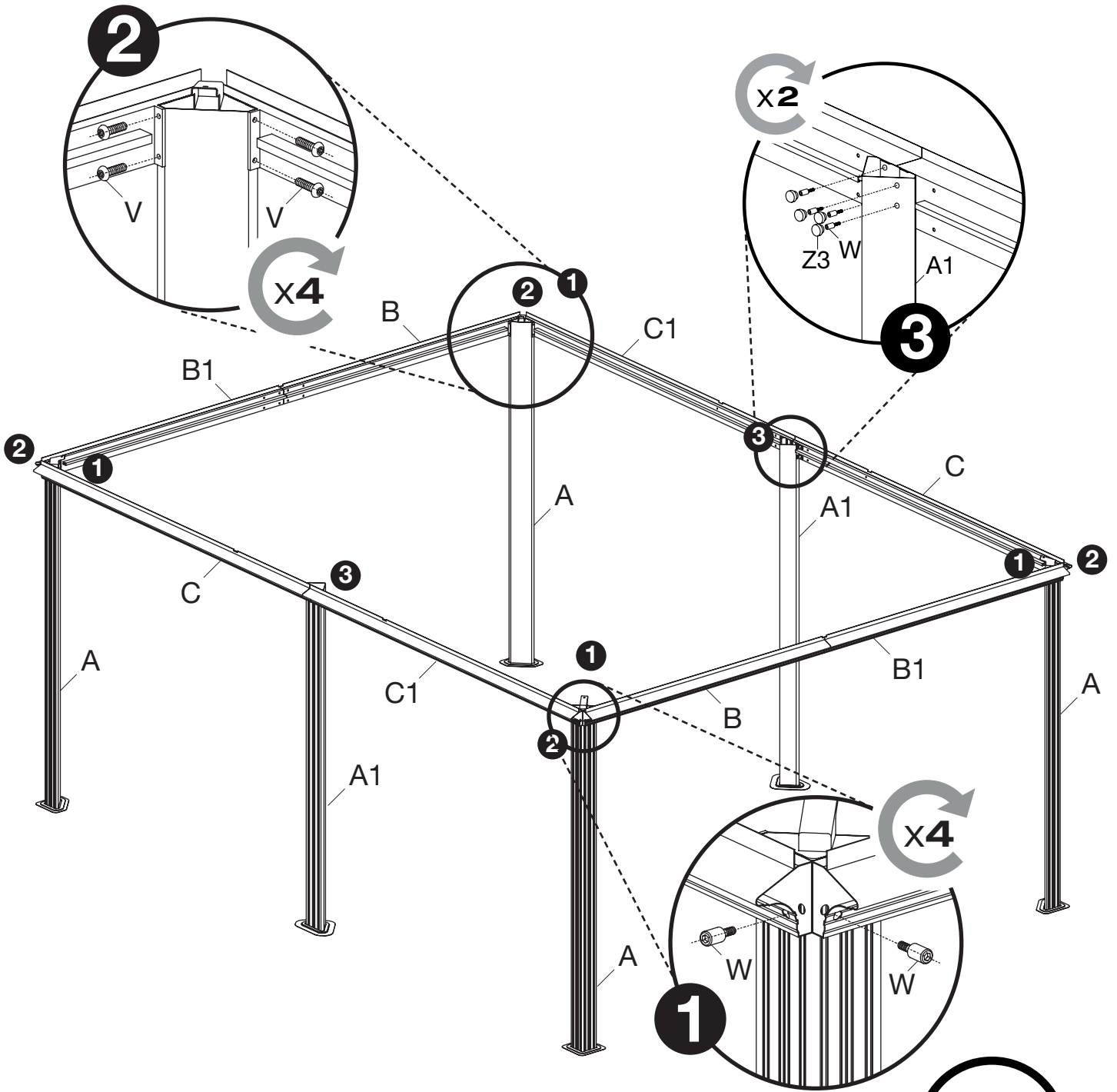

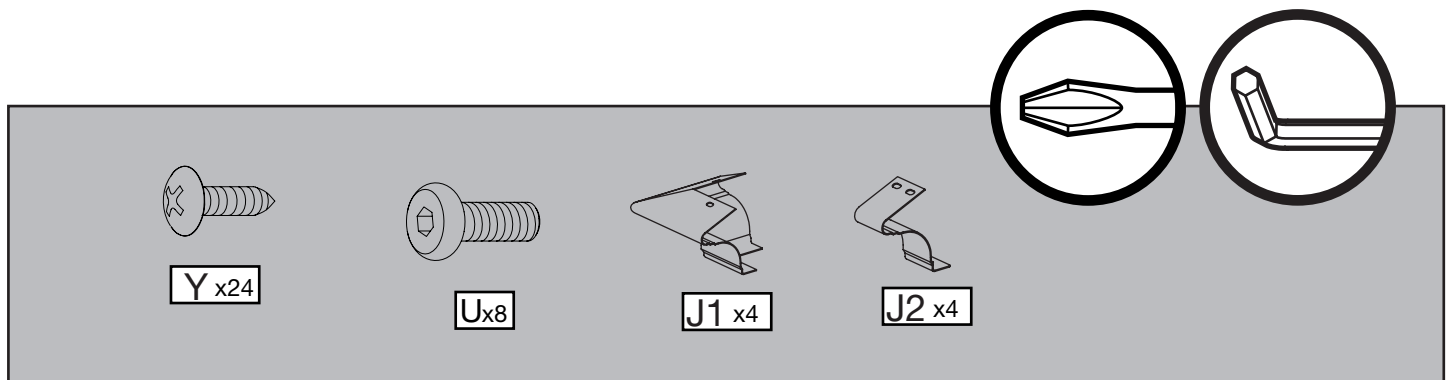
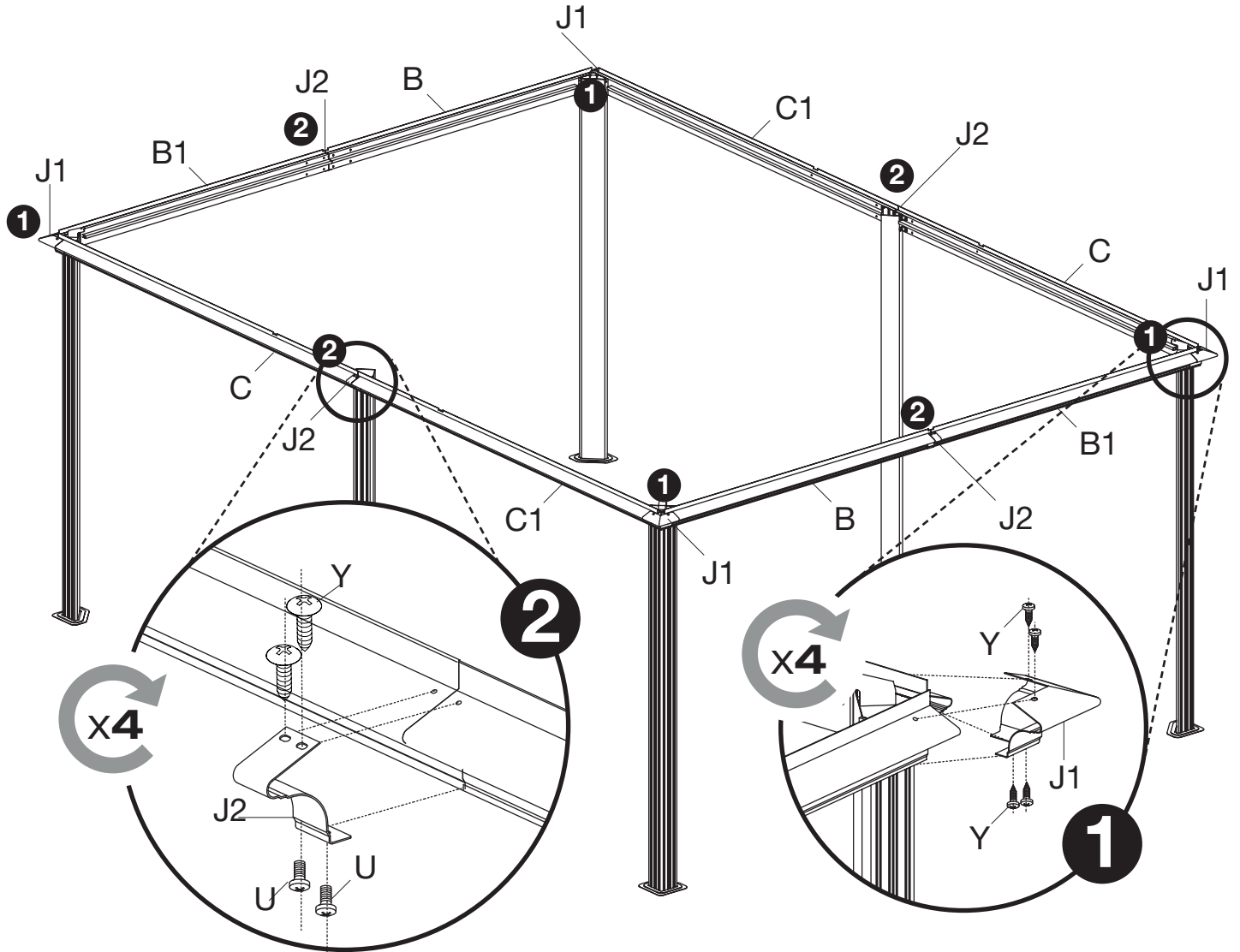

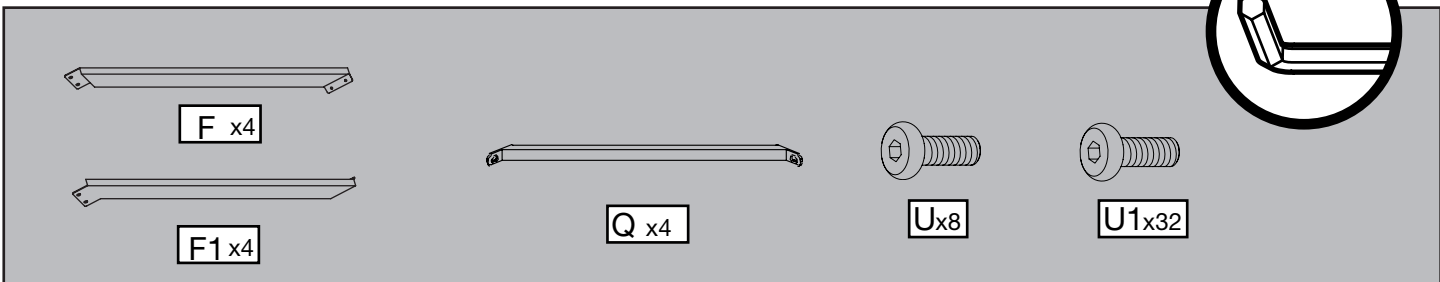
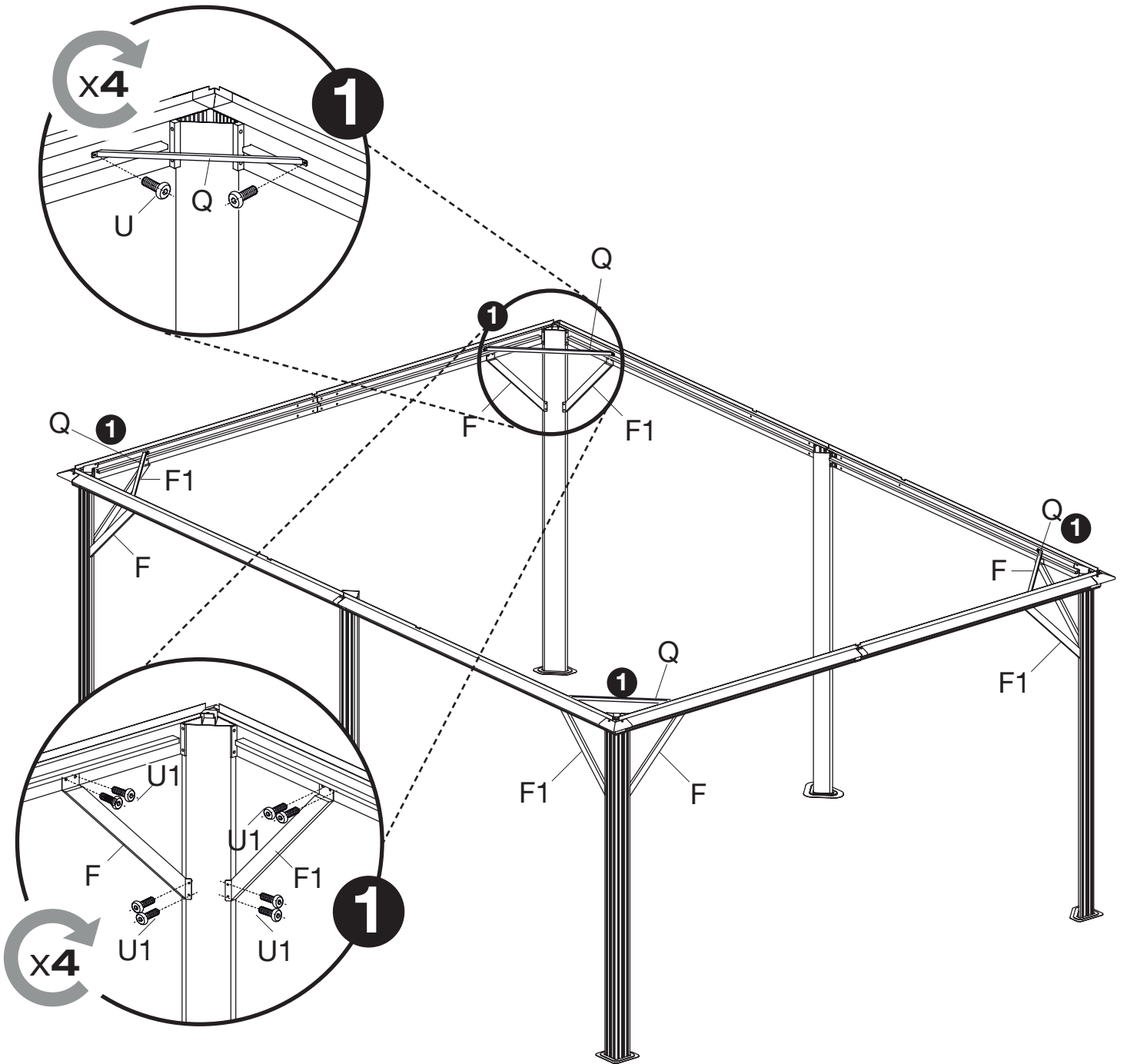

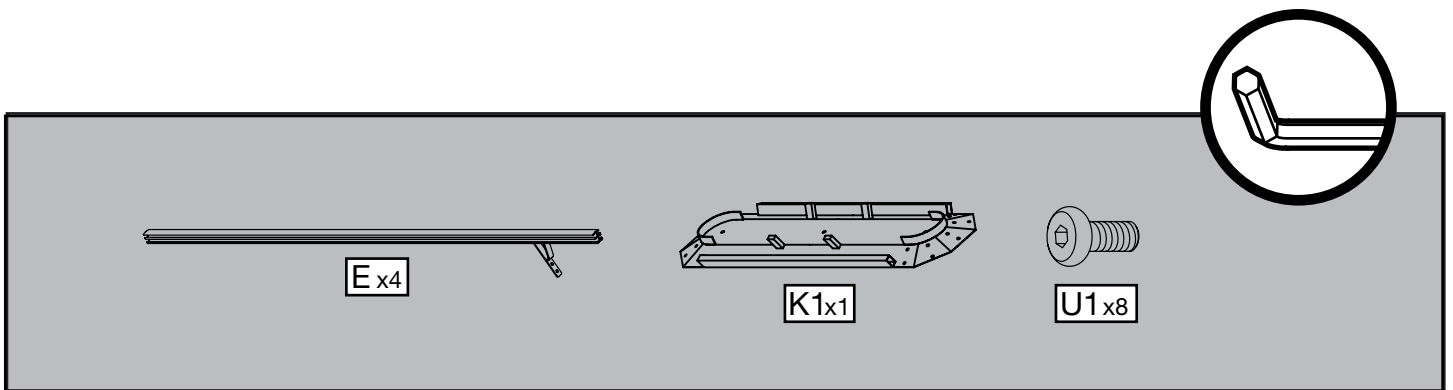
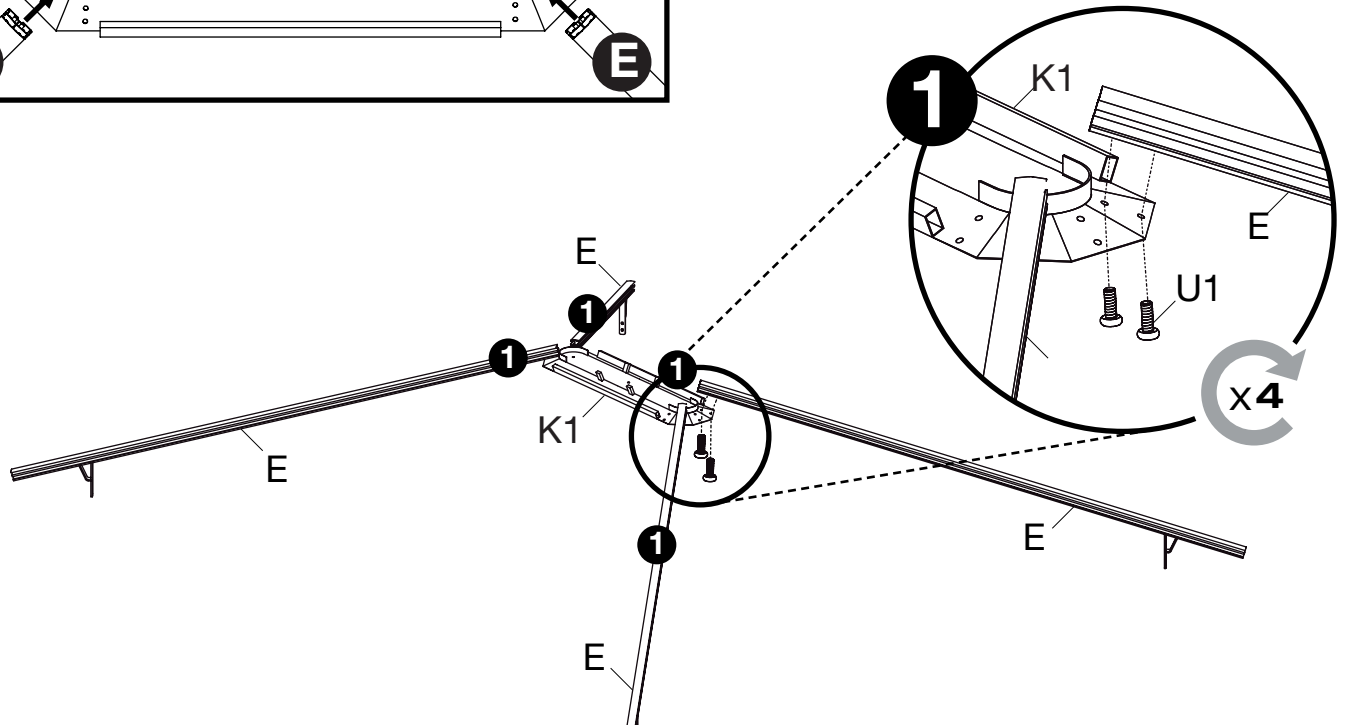
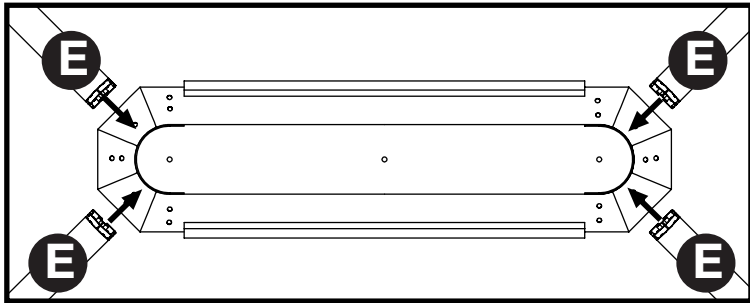

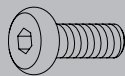
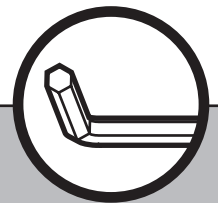
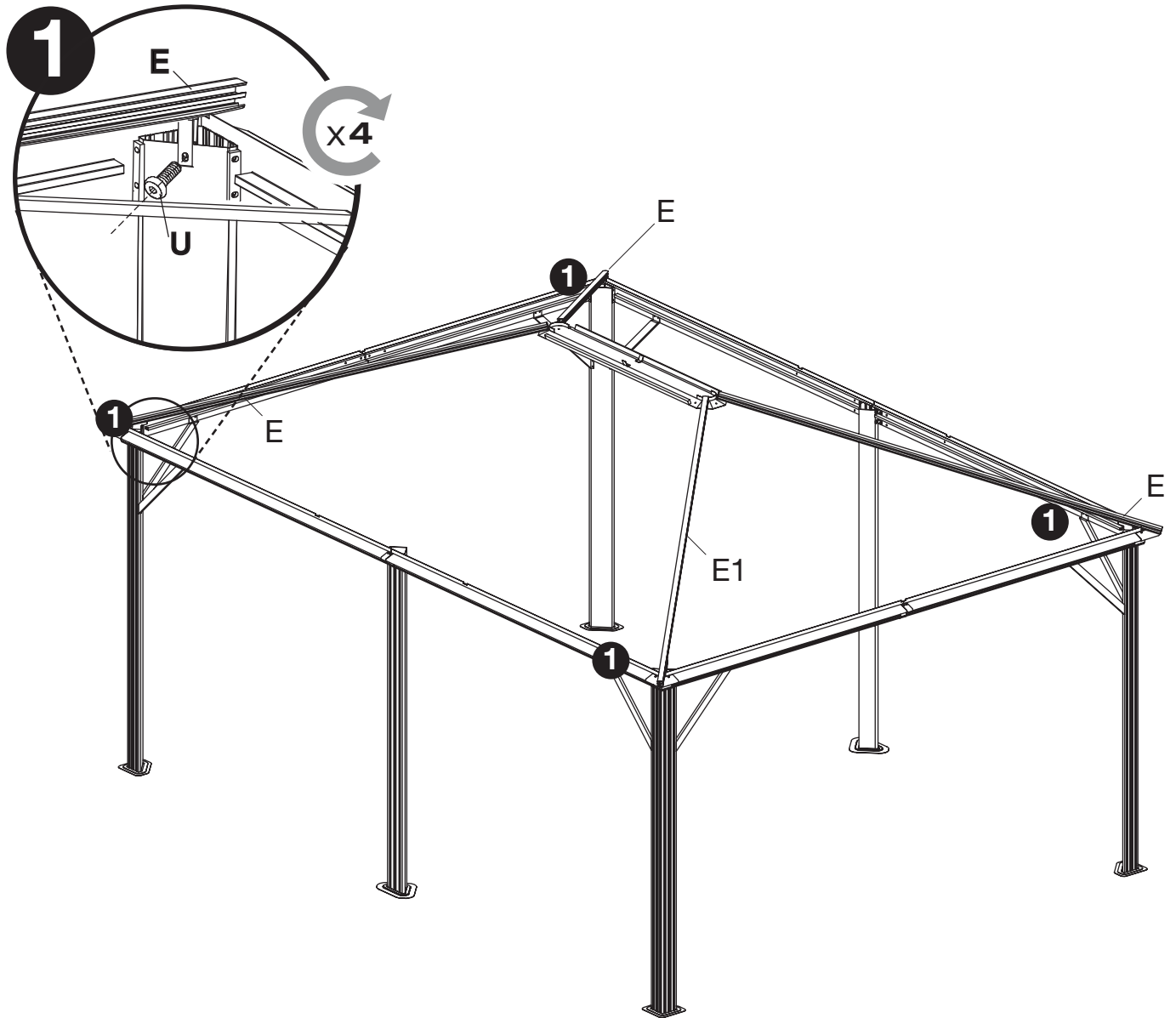

Ux4

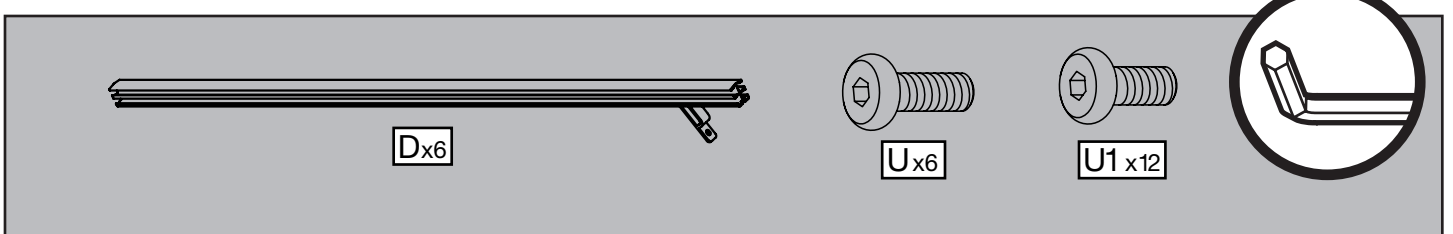
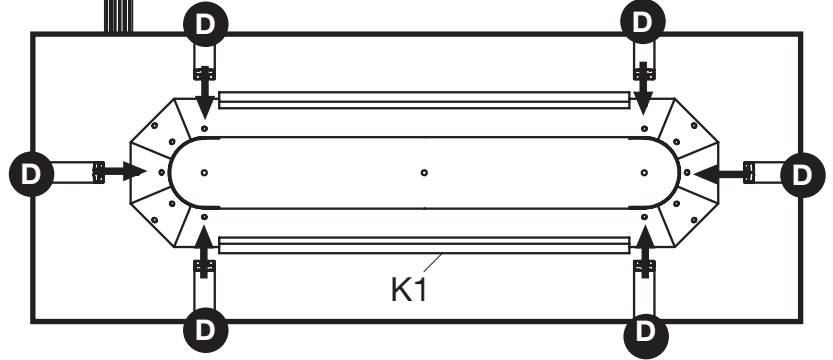
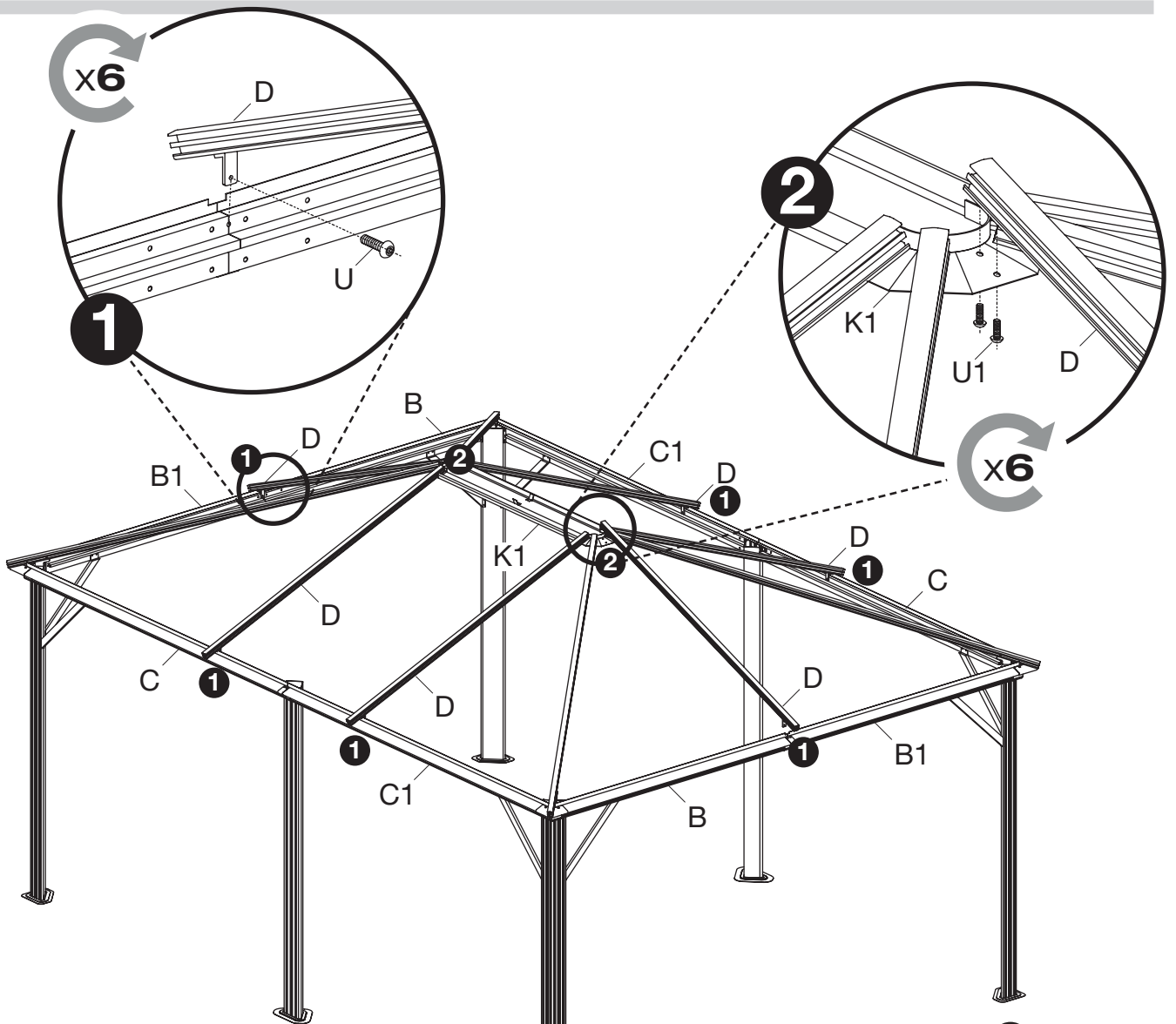

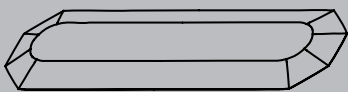
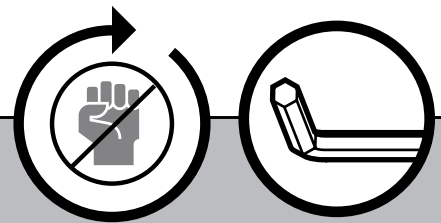
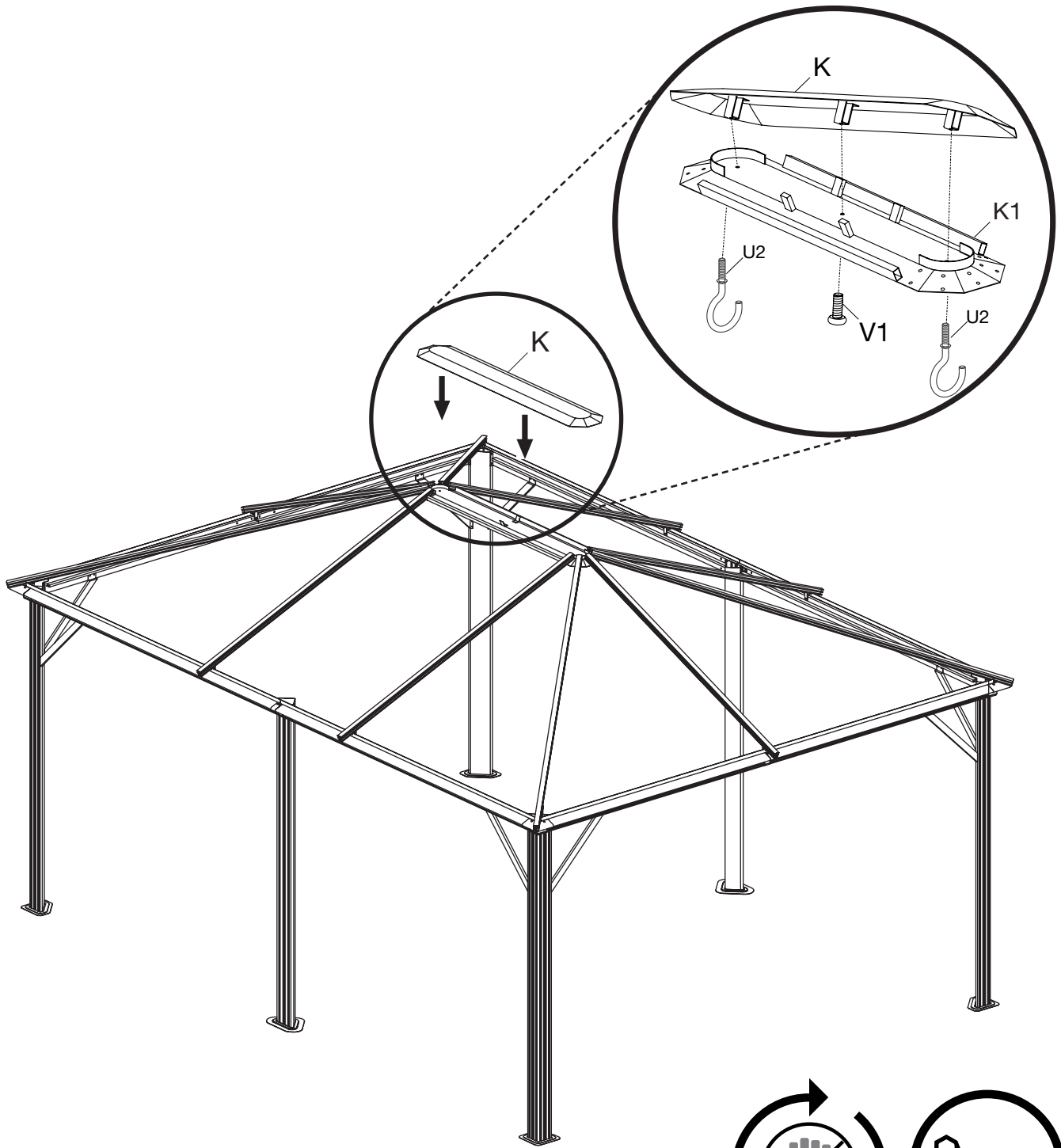

Kx1

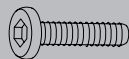

V1 x1



U2 x2



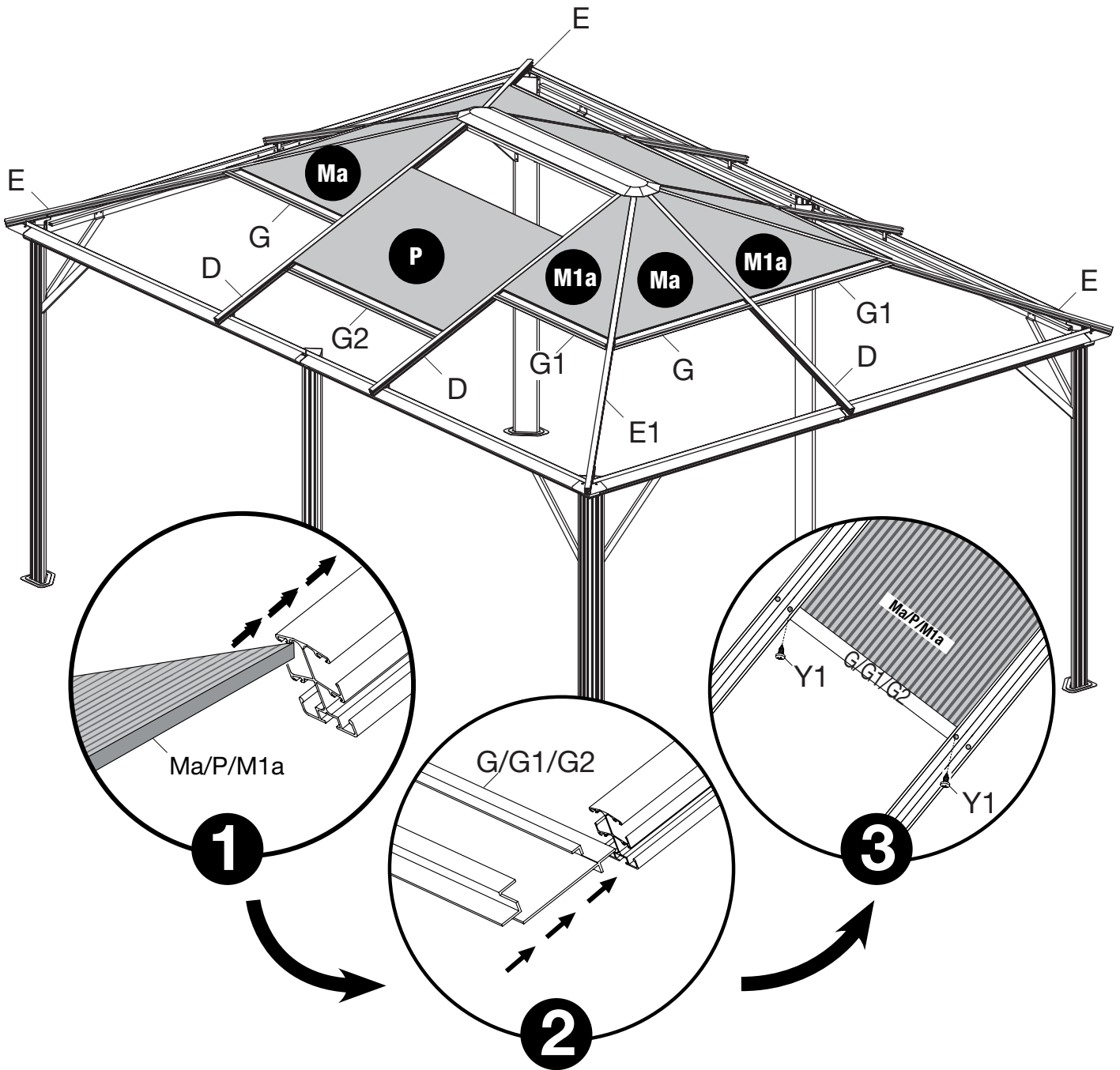

A parts list and safety icon are located at the bottom of the page. The parts list includes:

- Ma x4 (four triangular panels)
- P x2 (two rectangular panels)
- M1a x4 (four trapezoidal panels)
- Y1 x20 (twenty screws)
- G x4 (four beams)
- G1 x4 (four beams)
- G2 x2 (two beams)

A safety icon of a pair of hands is also present.

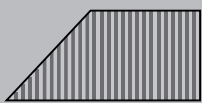
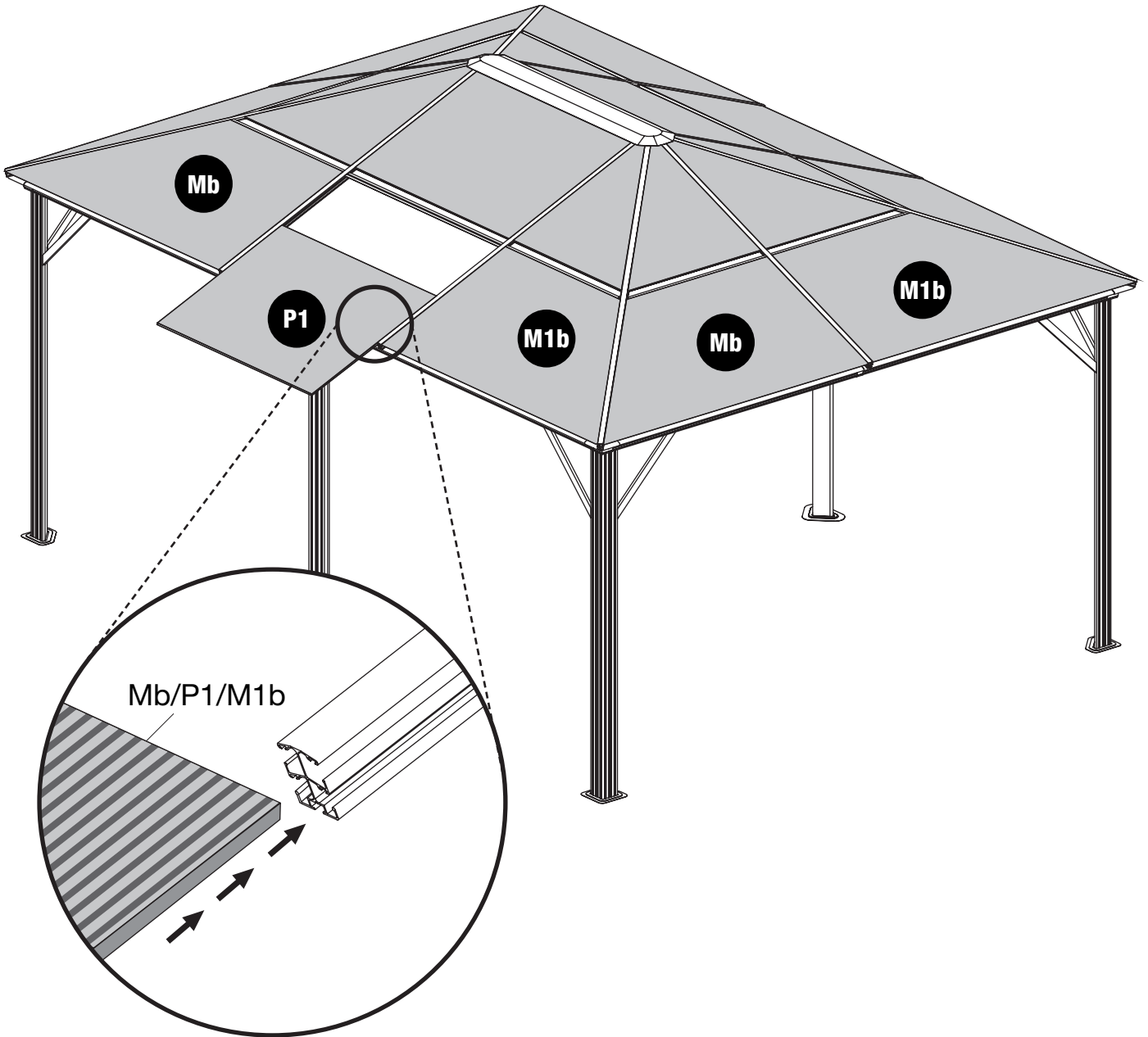

Mb<sub>x4</sub>

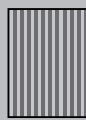



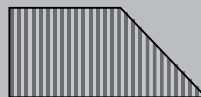

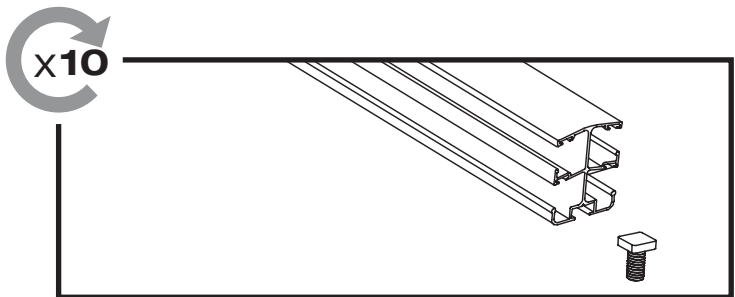
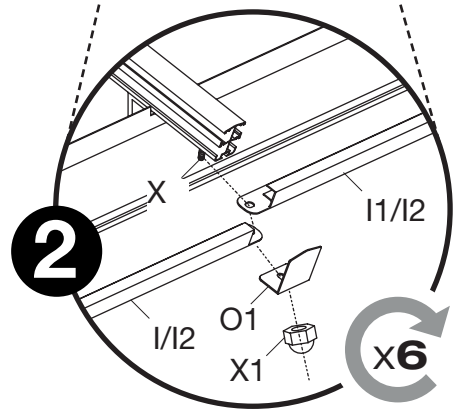
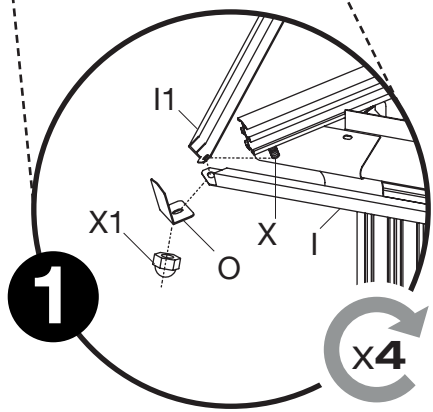
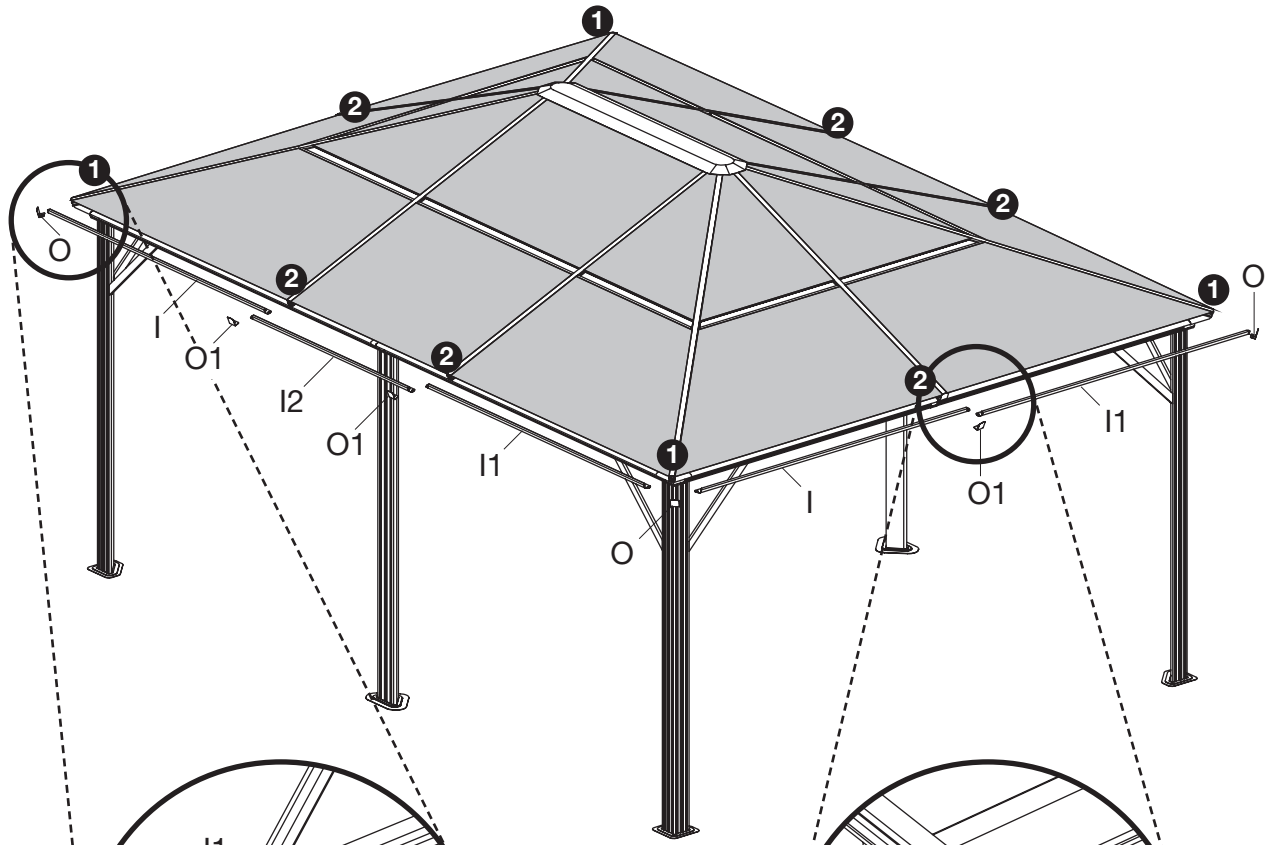

P1<sub>x2</sub>



M1b<sub>x4</sub>



				
I x4	I2 x2			
				
I1 x4	O x4	O1 x6	X x10	X1 x10

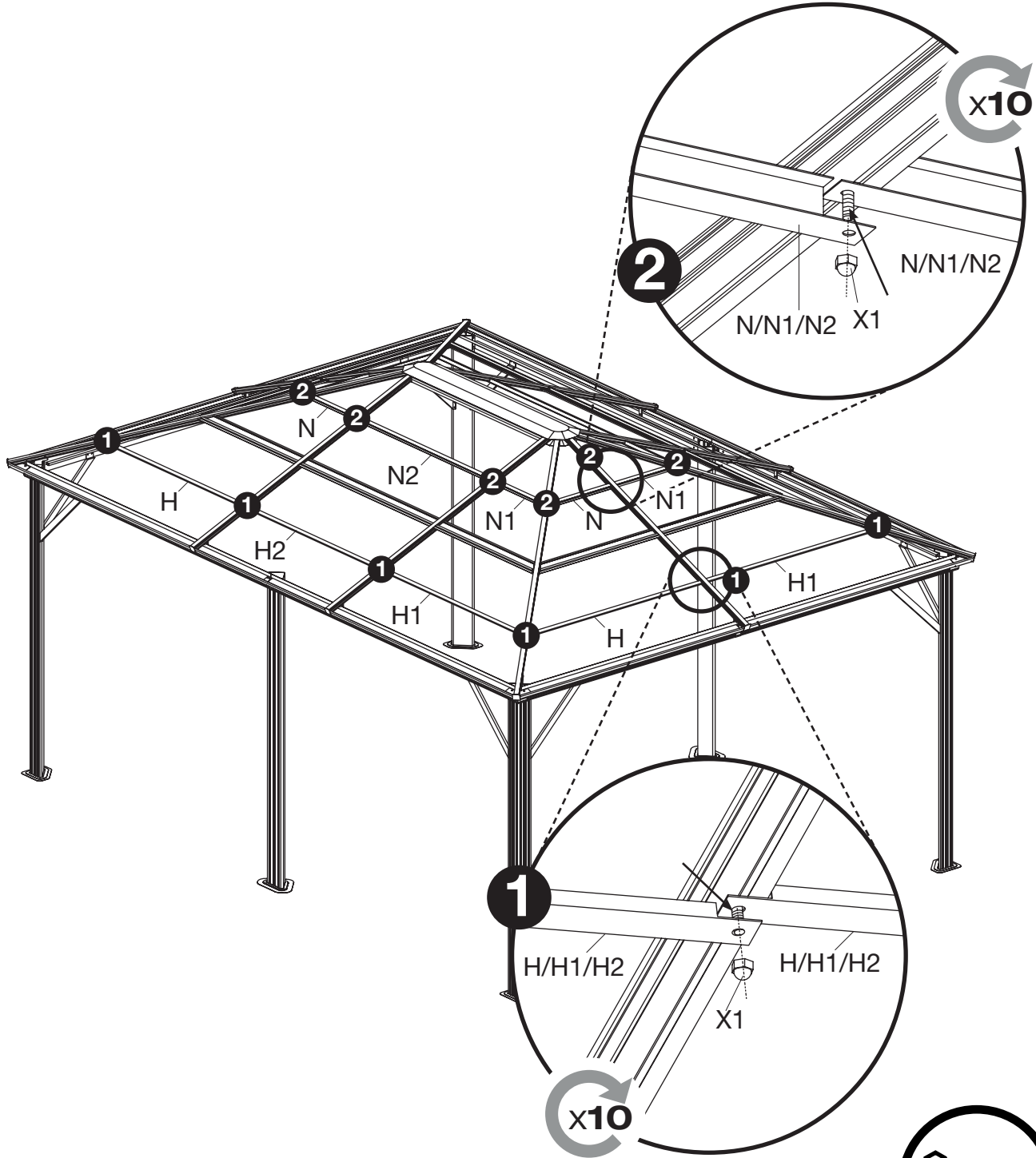

- |  |  |  |  |
|--|--|--|--|
|  |  |  |  |
|  |  |  |  |

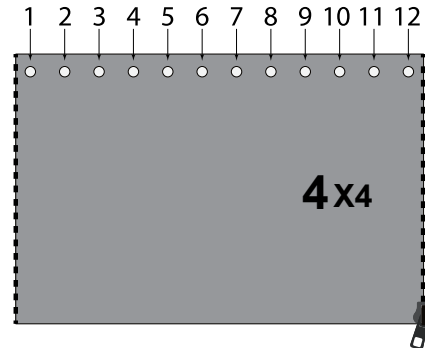
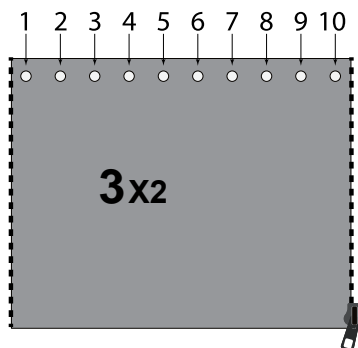
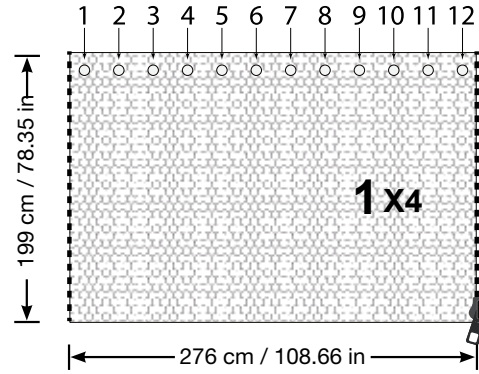
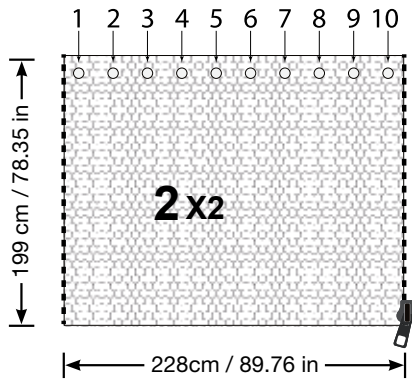
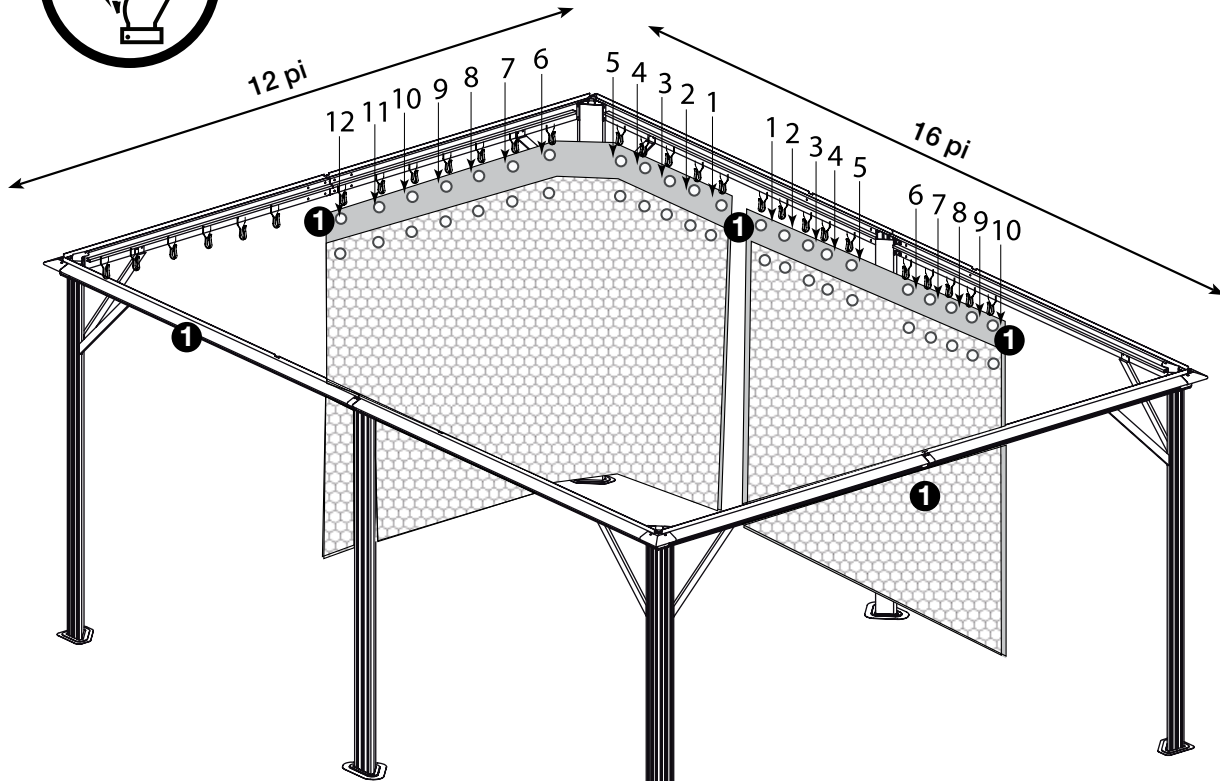
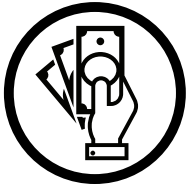





**SOJAG** ■ I  
produits saisonniers • seasonal products