

1803

SOUL SYR02

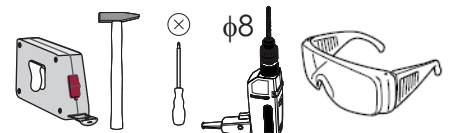

1

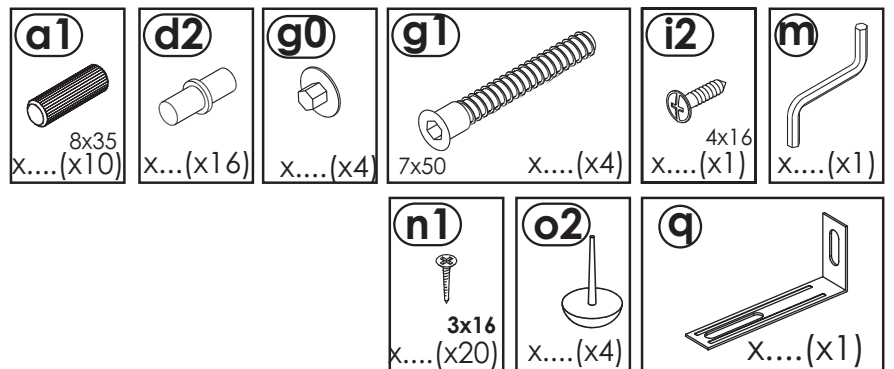
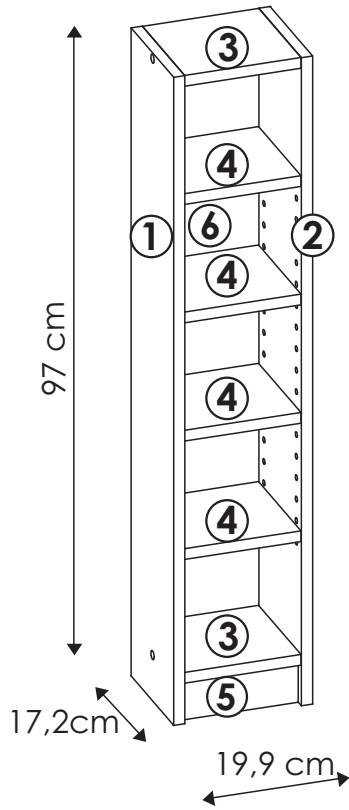
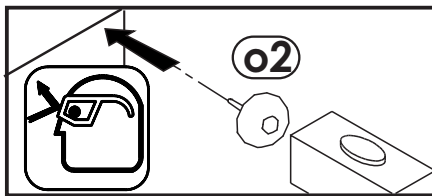
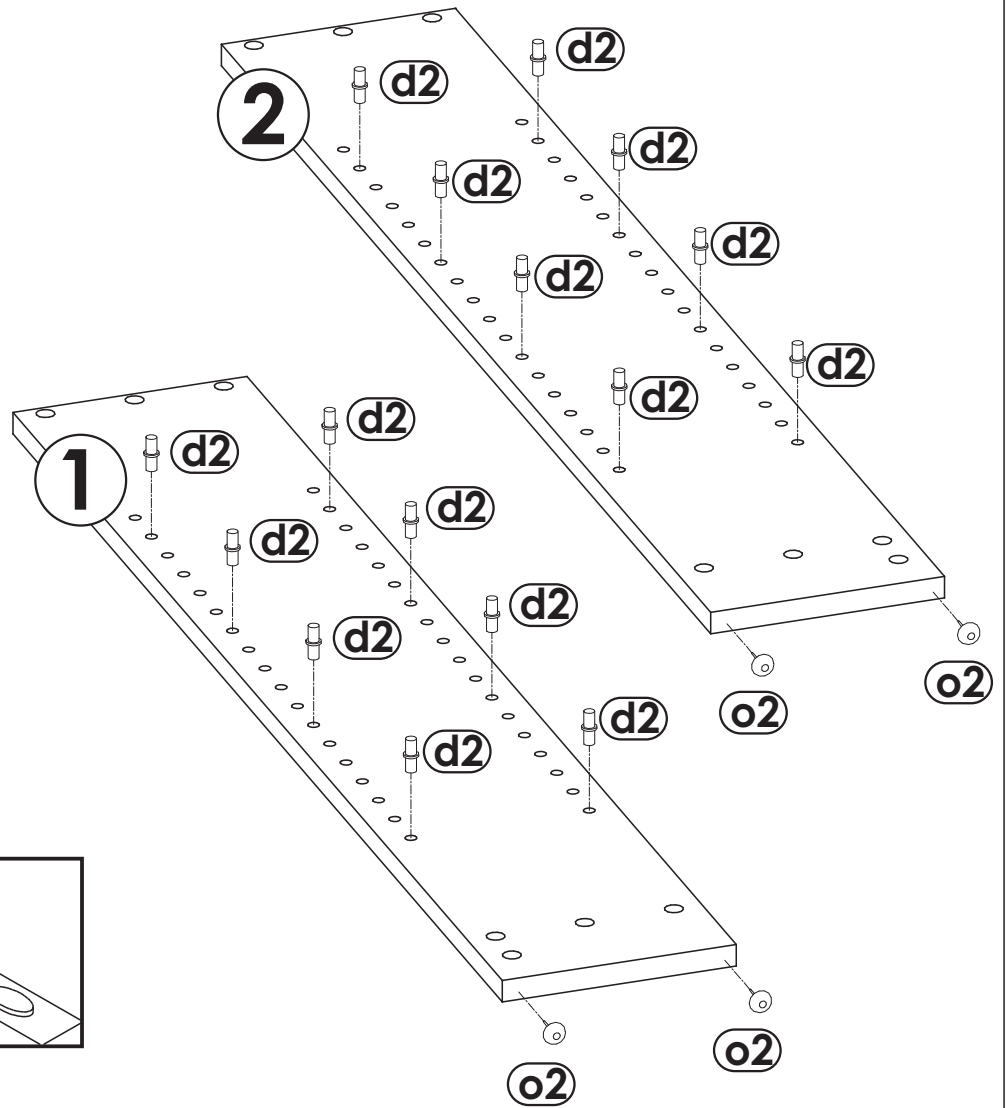
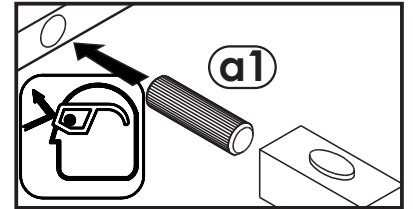
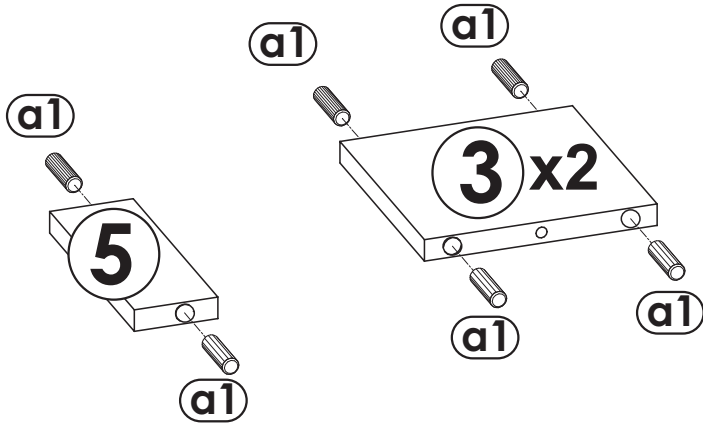
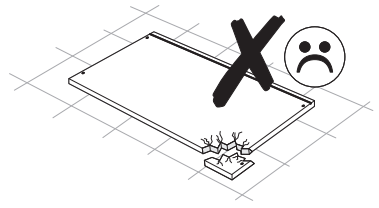
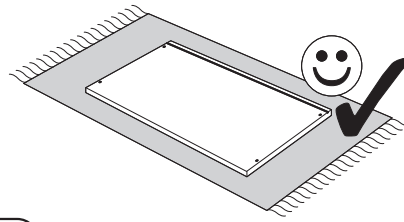

2

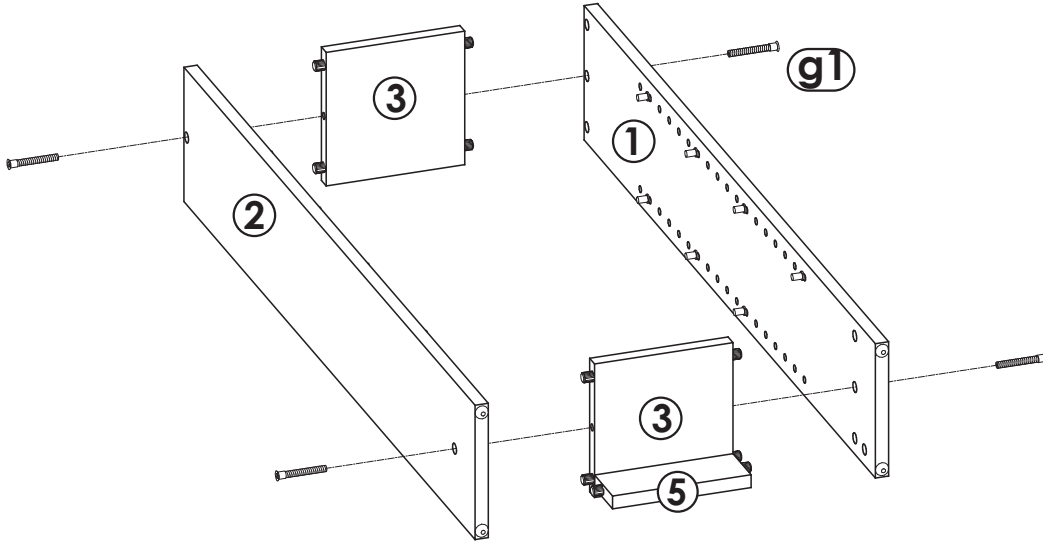
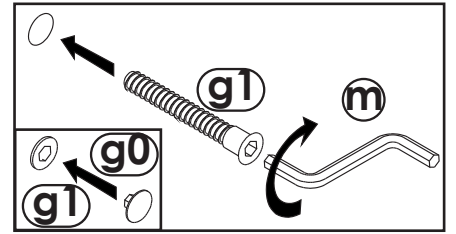
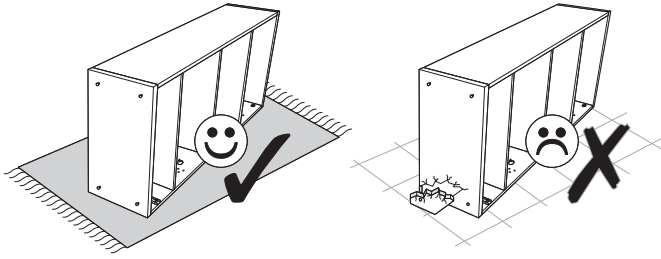

3

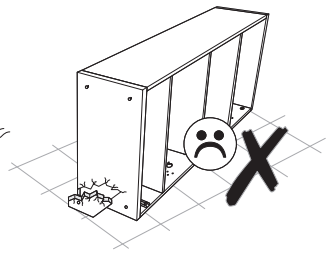
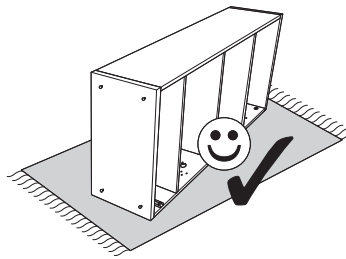
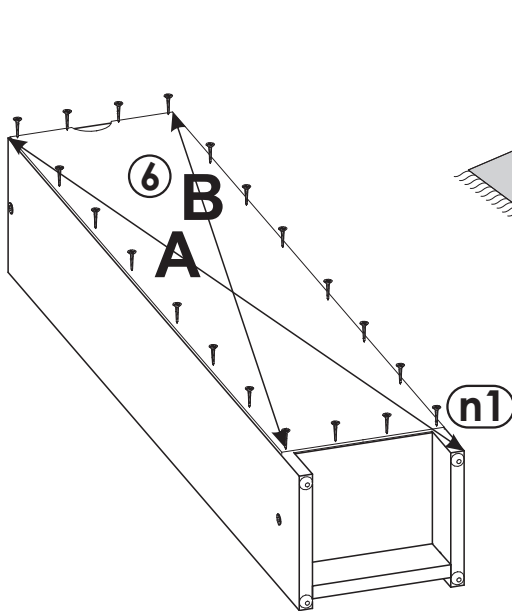

A=B

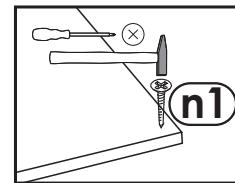

4
▼

