

5086996/00

W96

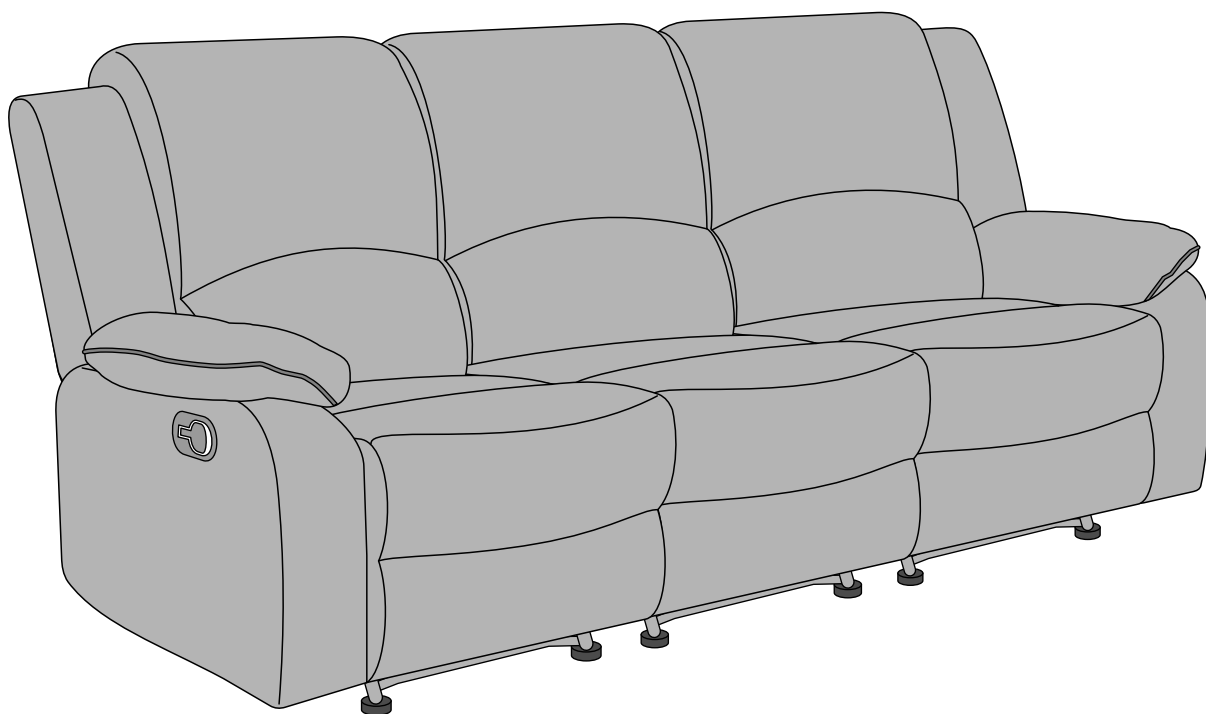

10-0679

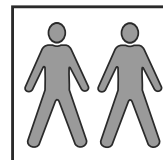

050419V1

Änderungen die der technischen Verbesserung dienen, behalten wir uns vor.

Subject to changes in the interests of technical improvements.

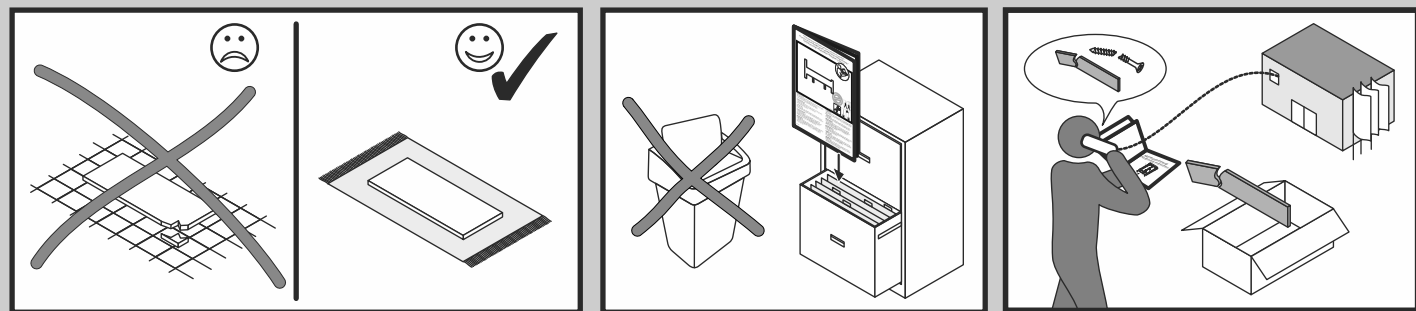

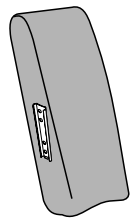
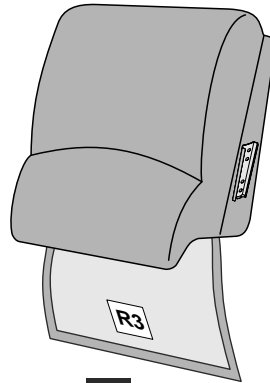
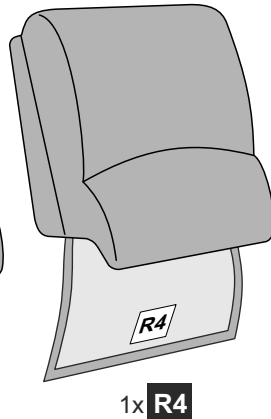
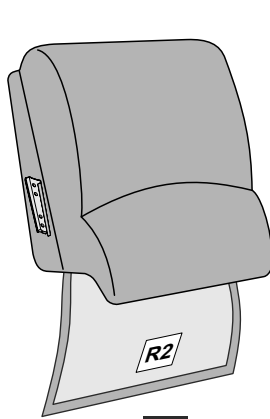
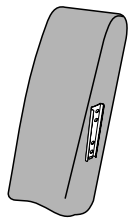
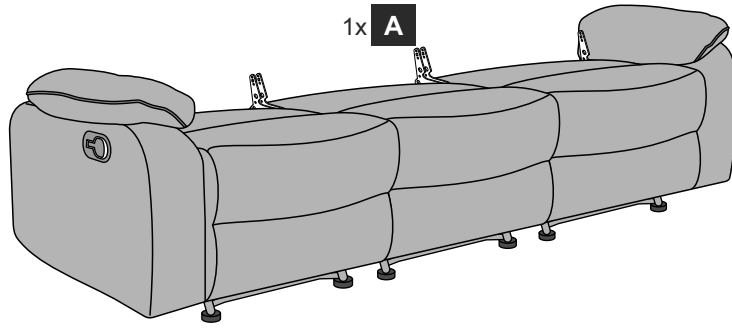

1.

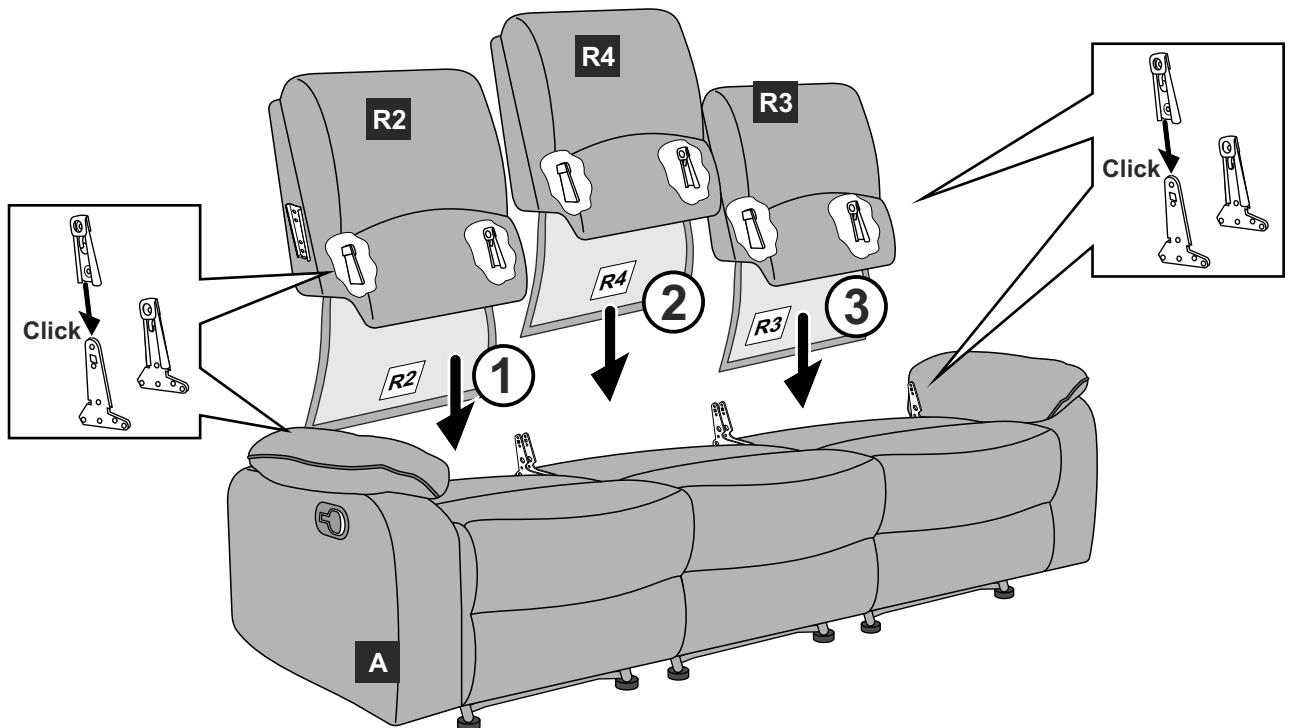

2.

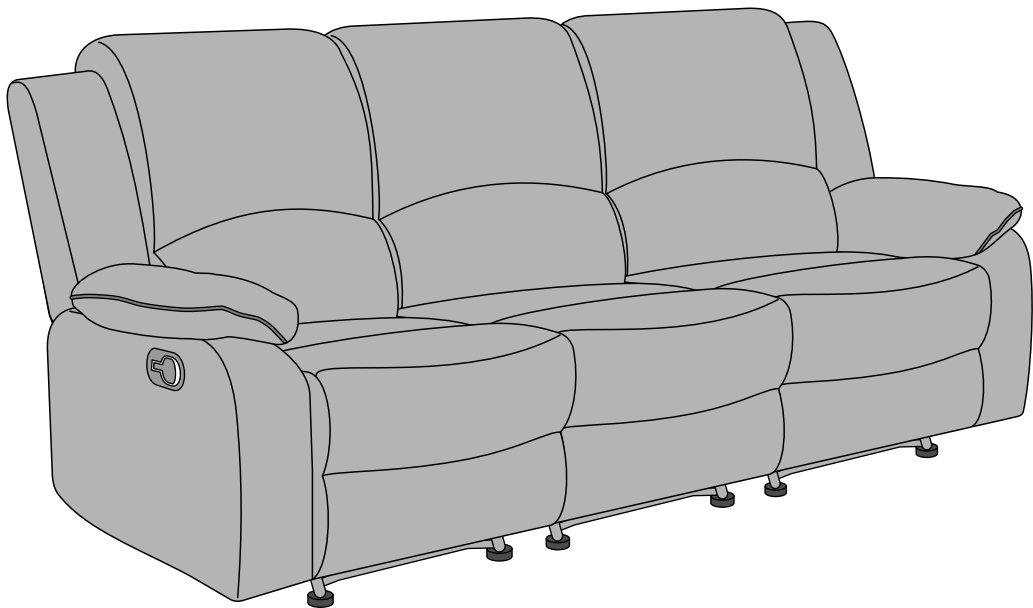
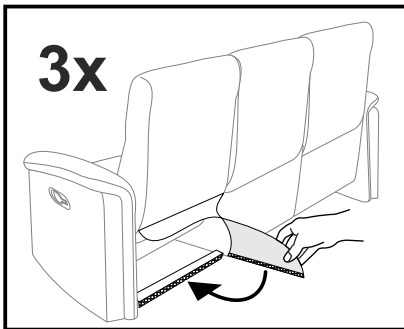
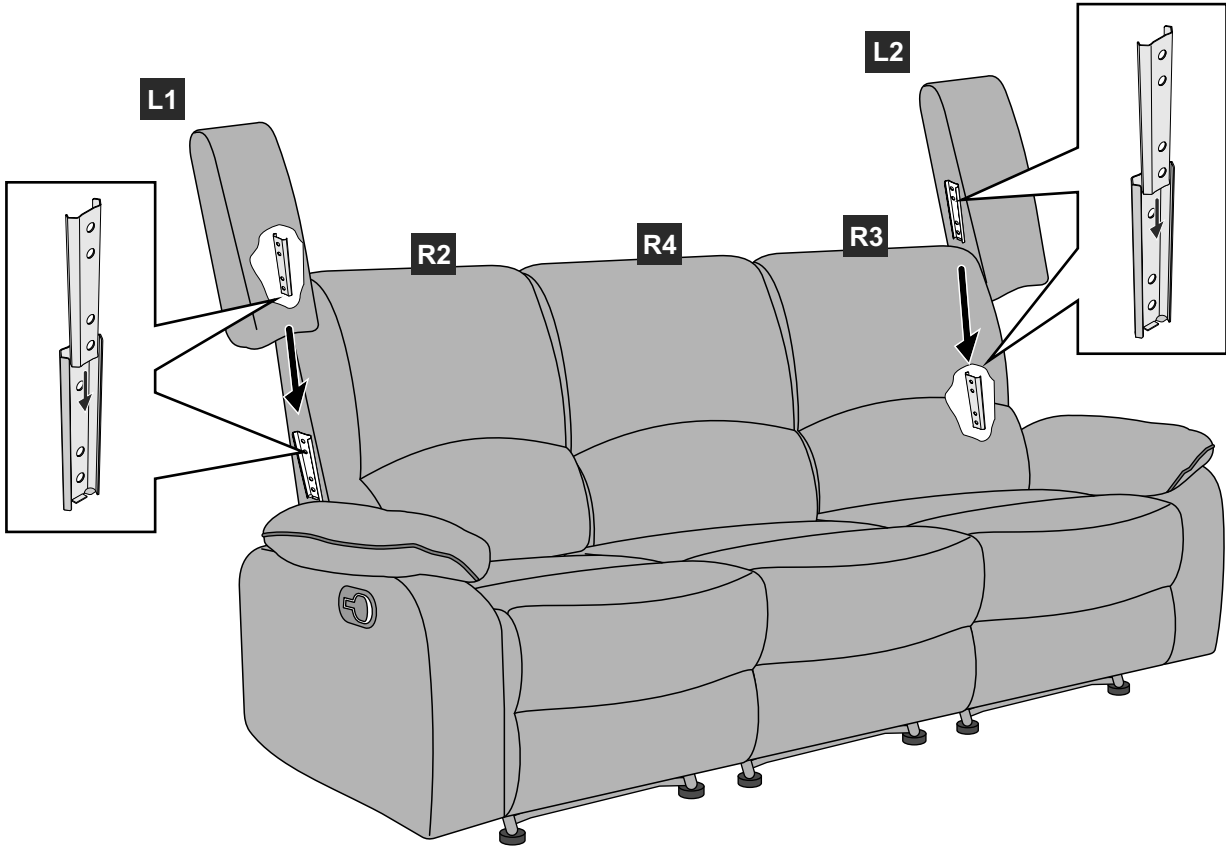

3.

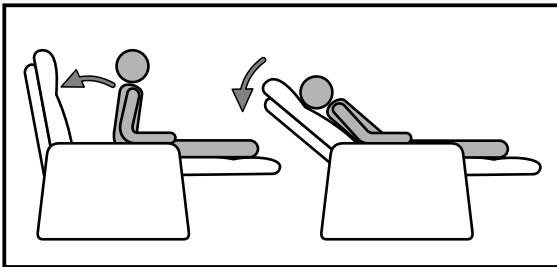
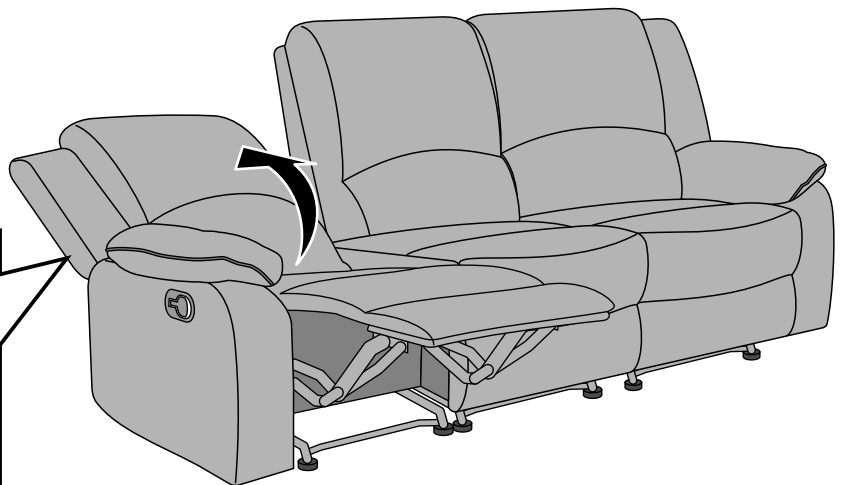
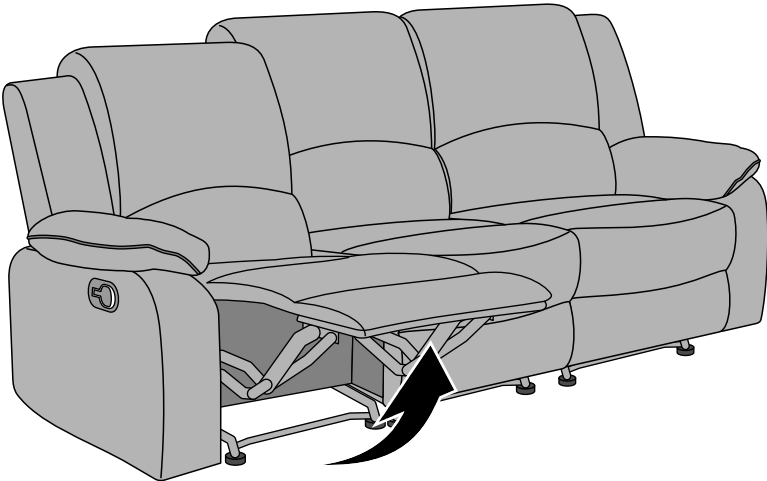
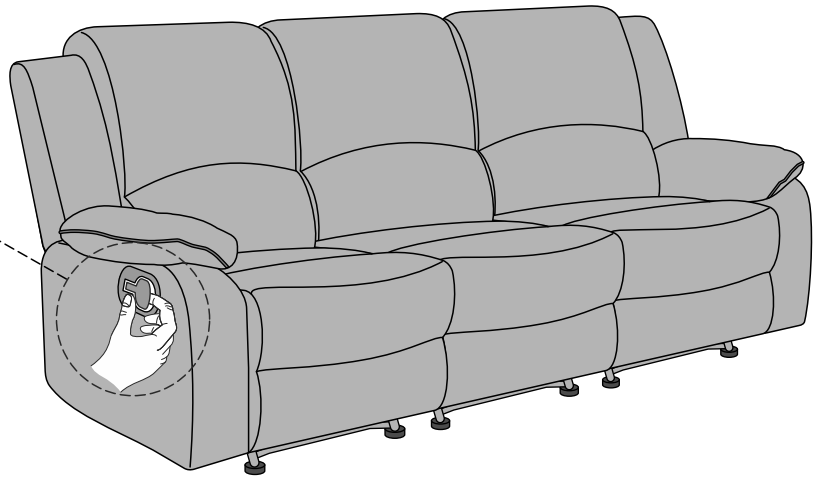
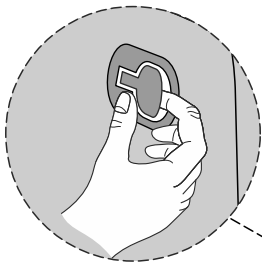

4.

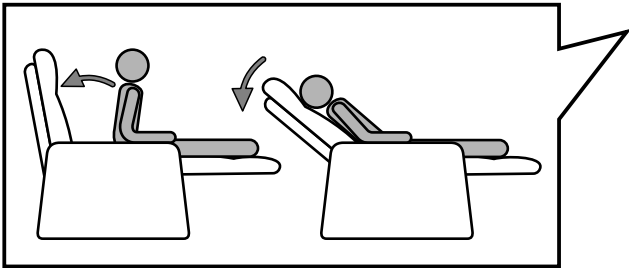
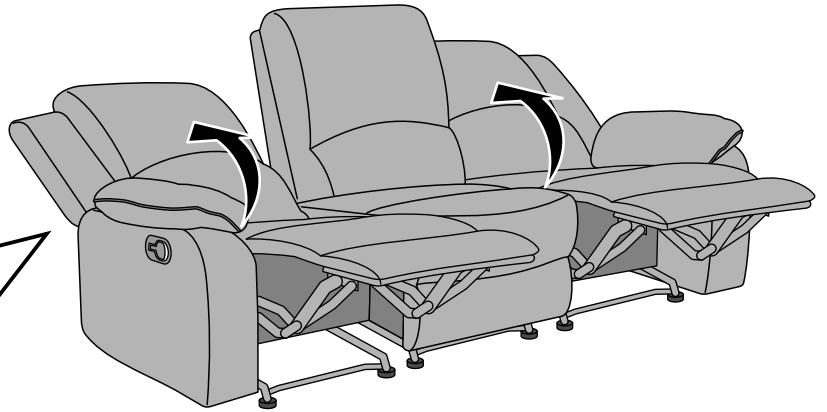
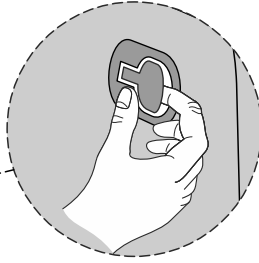
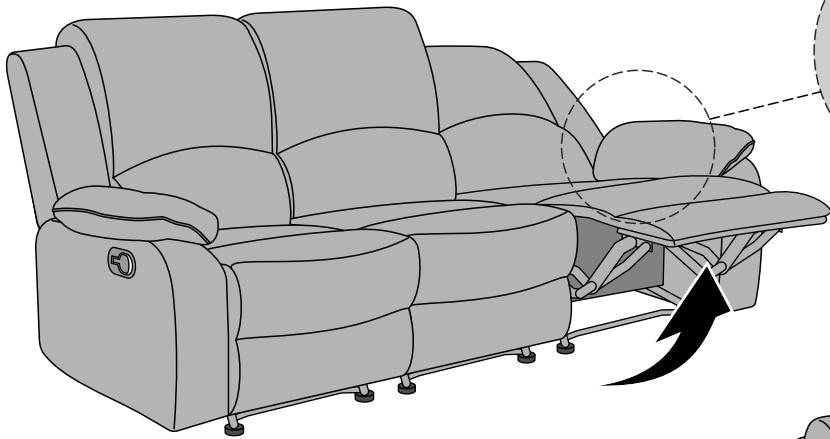

5.

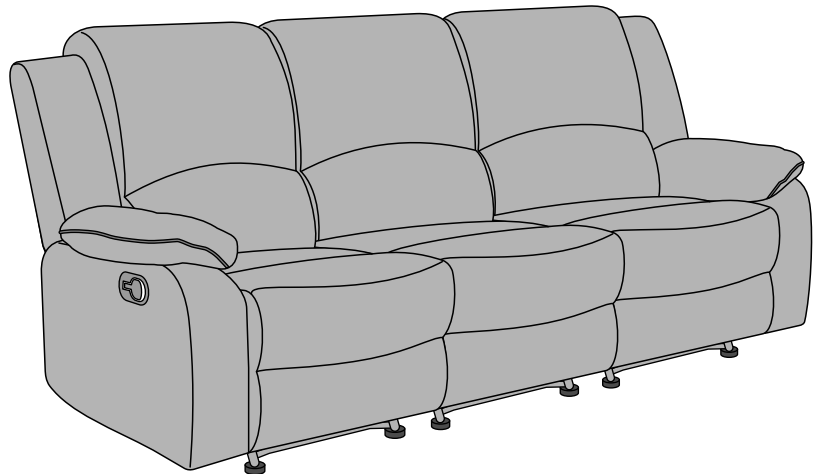
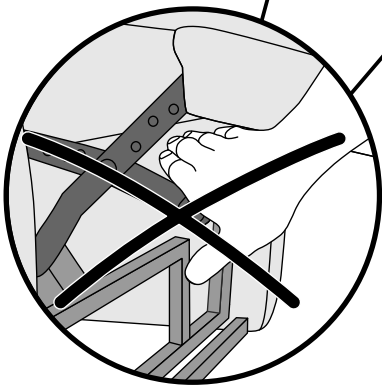
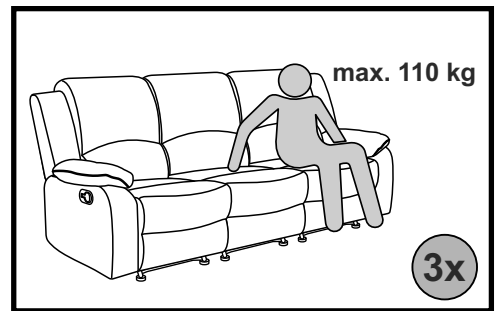
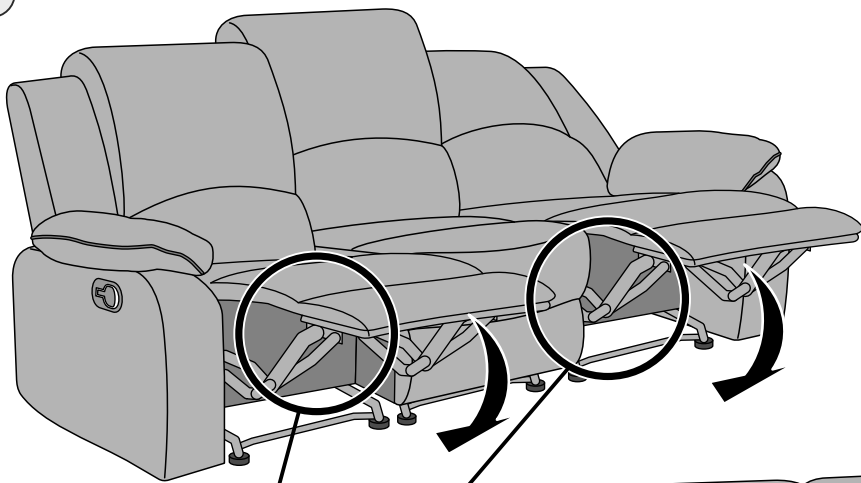

5086969/00

W96

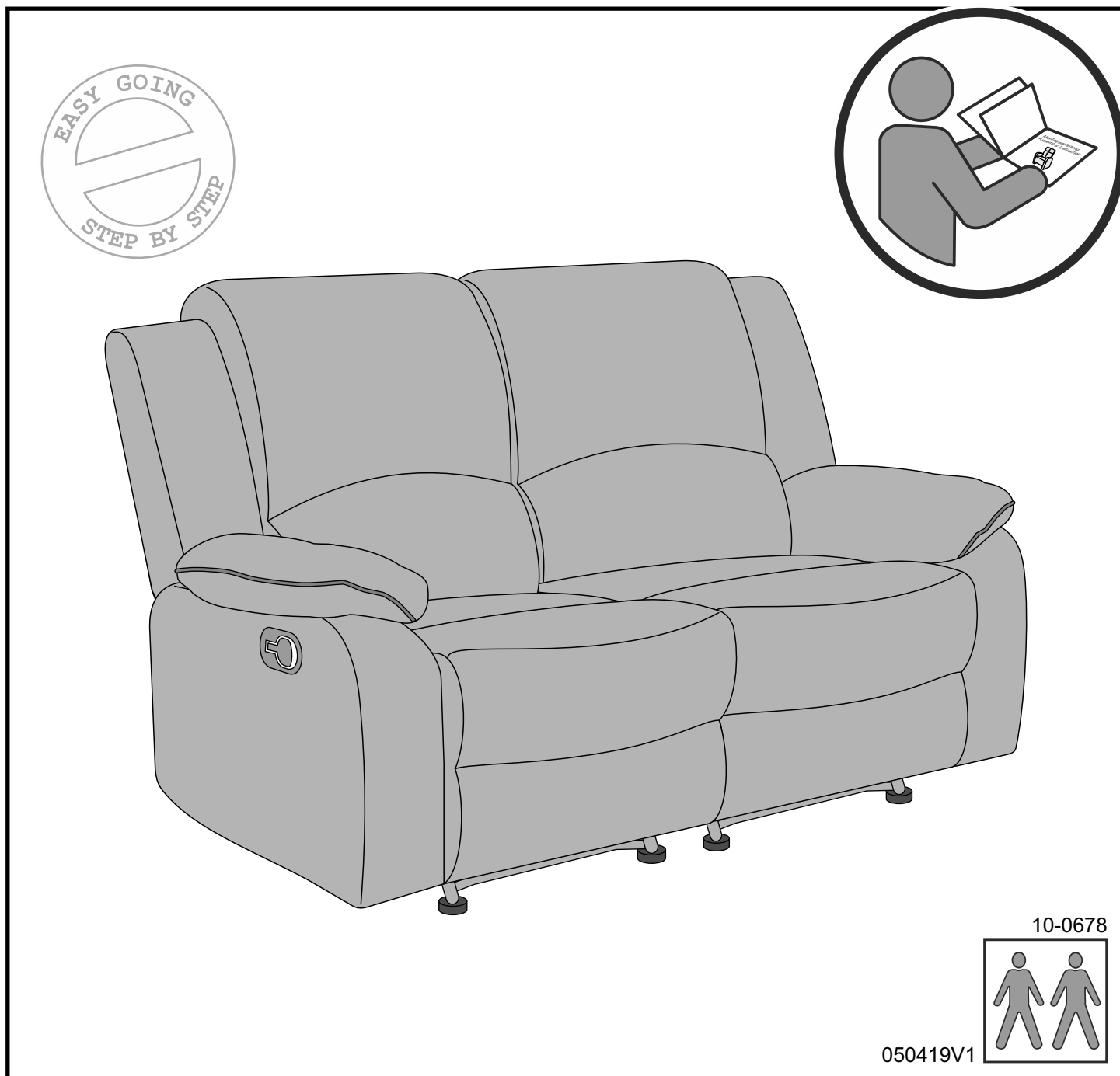

Änderungen die der technischen Verbesserung dienen, behalten wir uns vor.

Subject to changes in the interests of technical improvements.

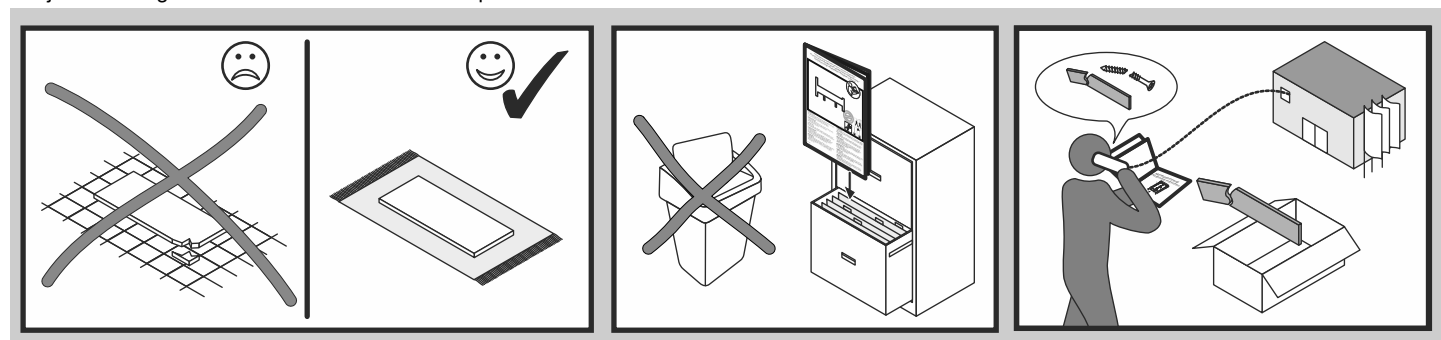

Colli

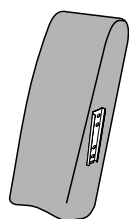
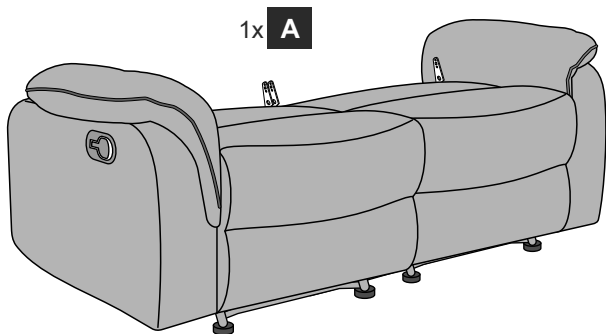

1x **L1**

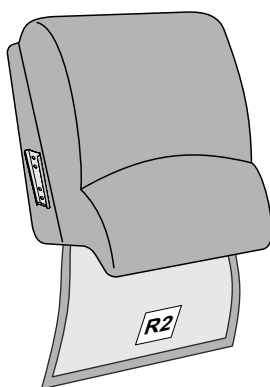

1x **R2**

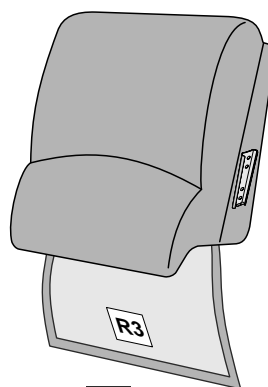

1x **R3**

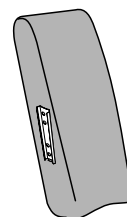

1x **L2**

1.

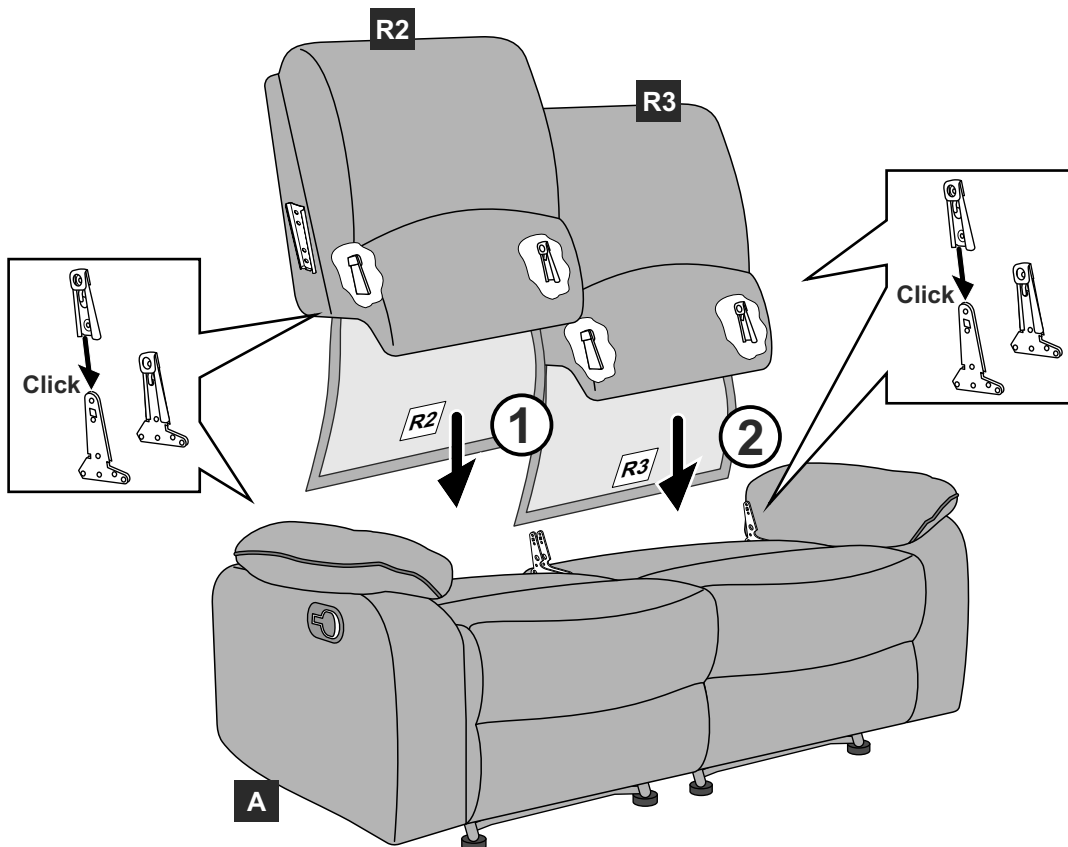

2.

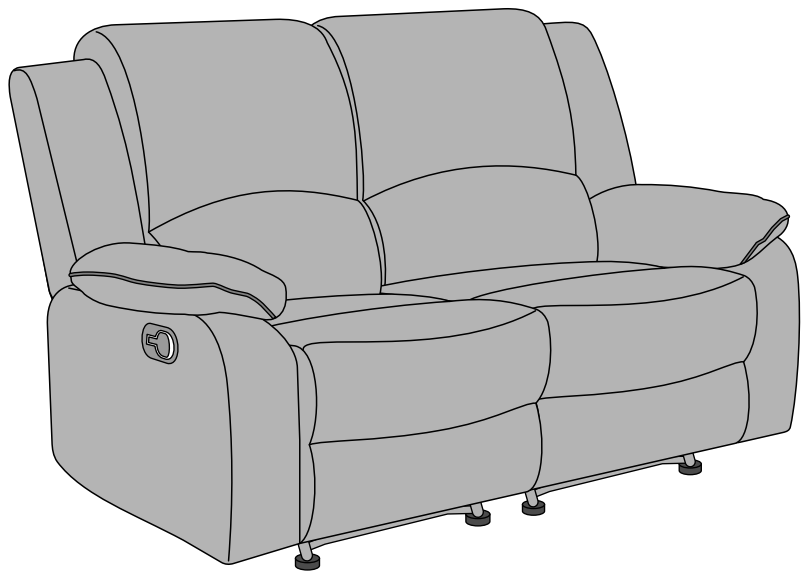
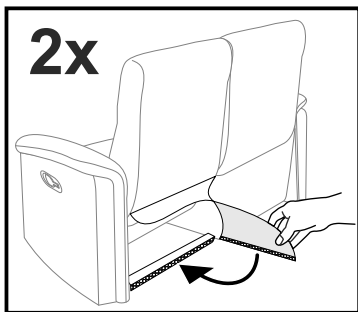
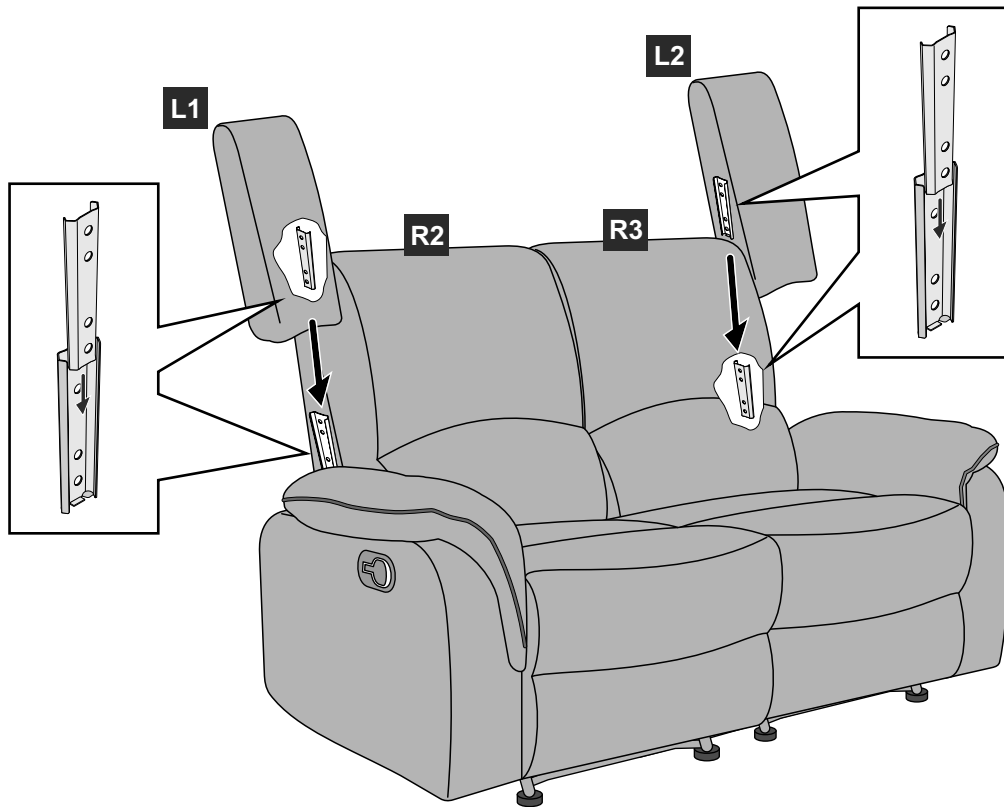

3.

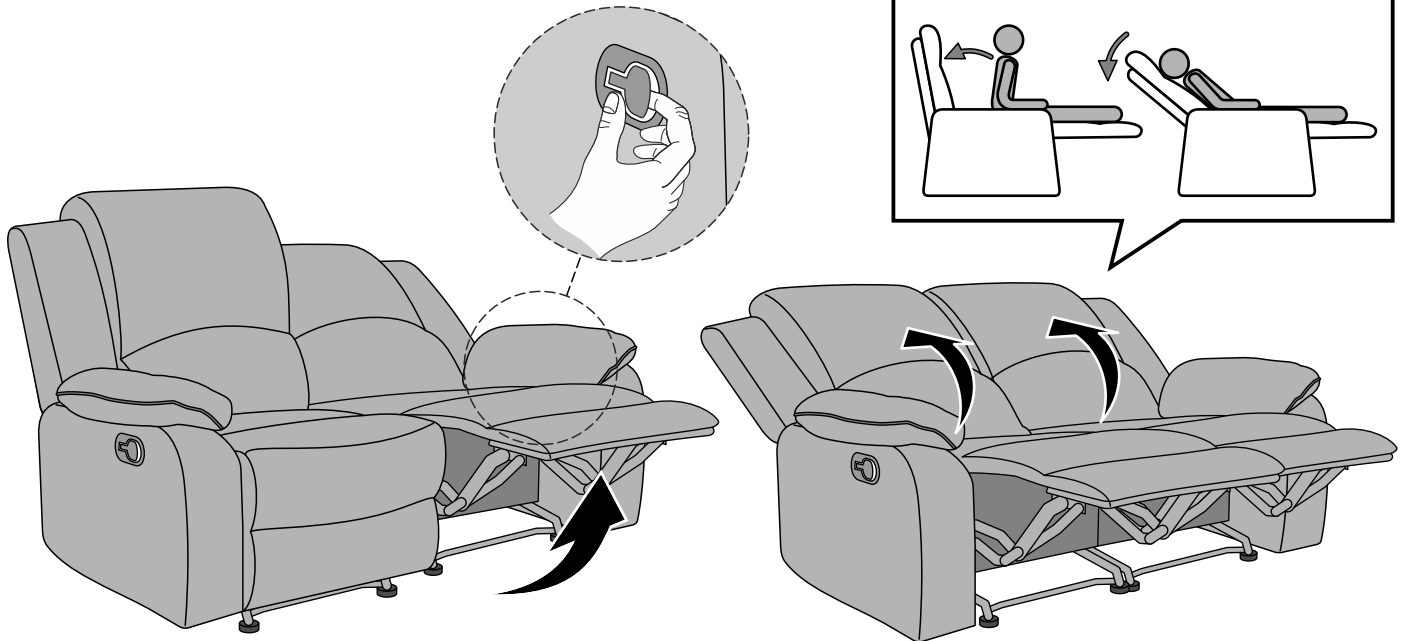
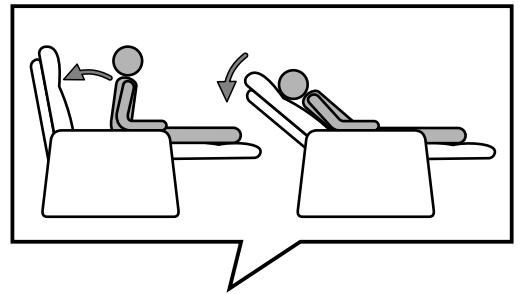
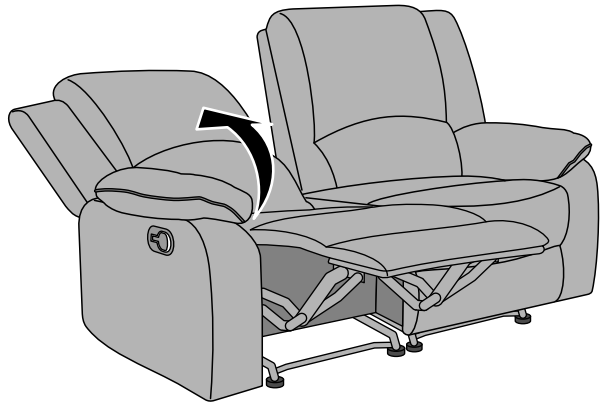
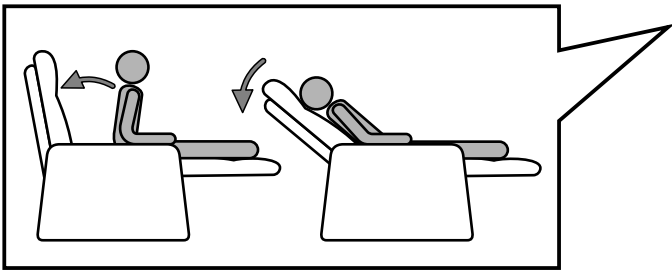
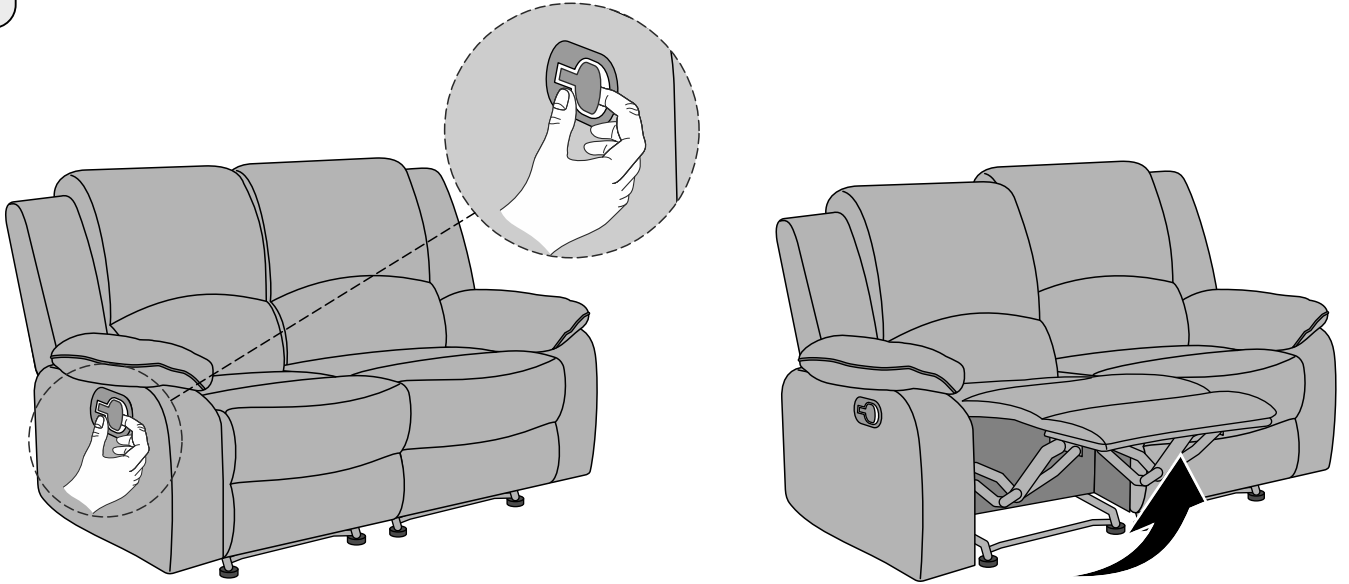

4.

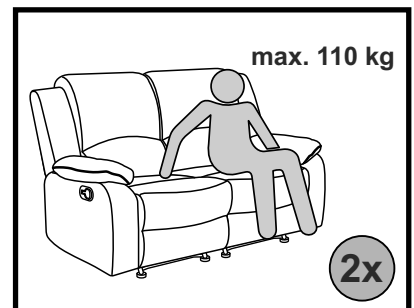
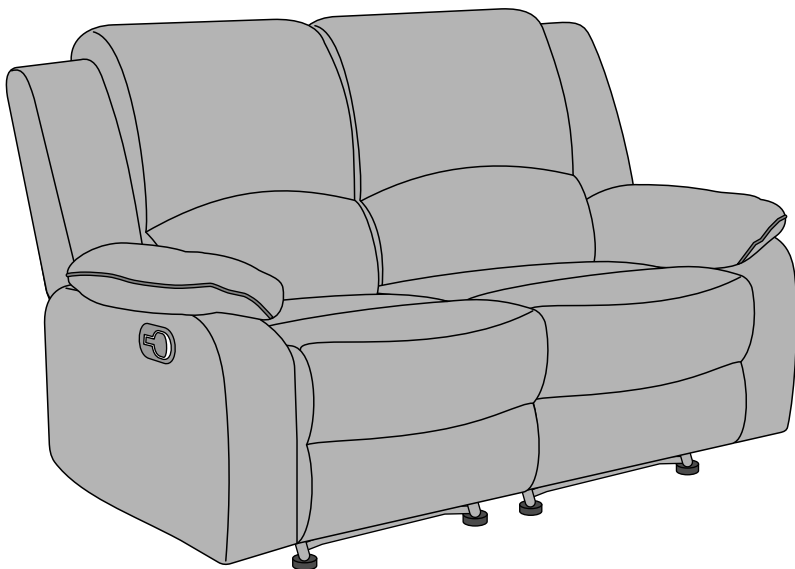
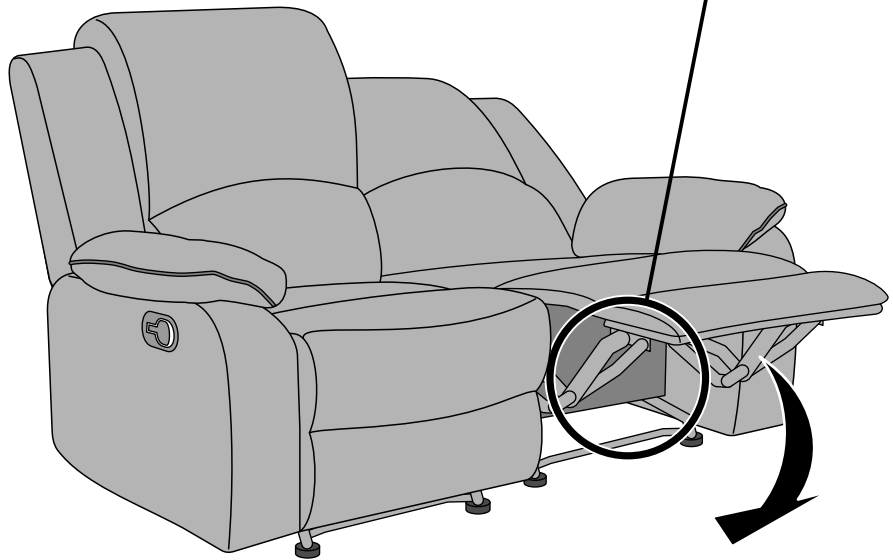
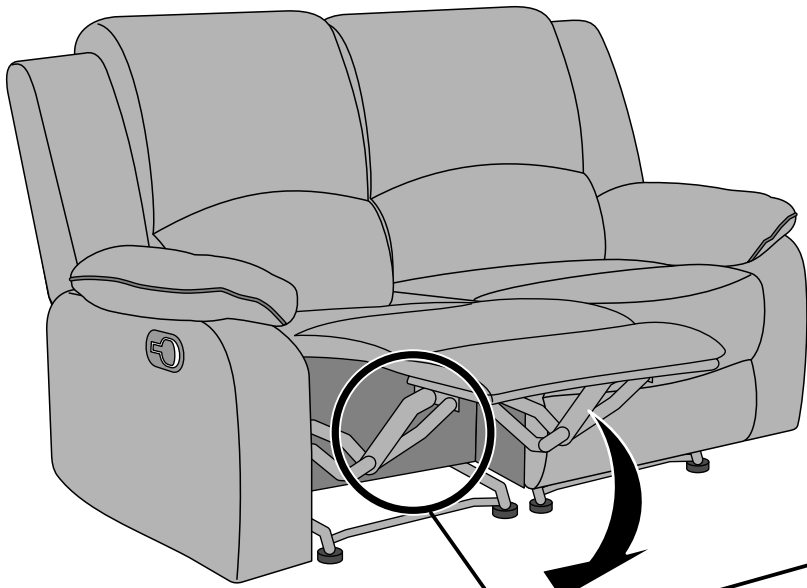

5086969/00

W96

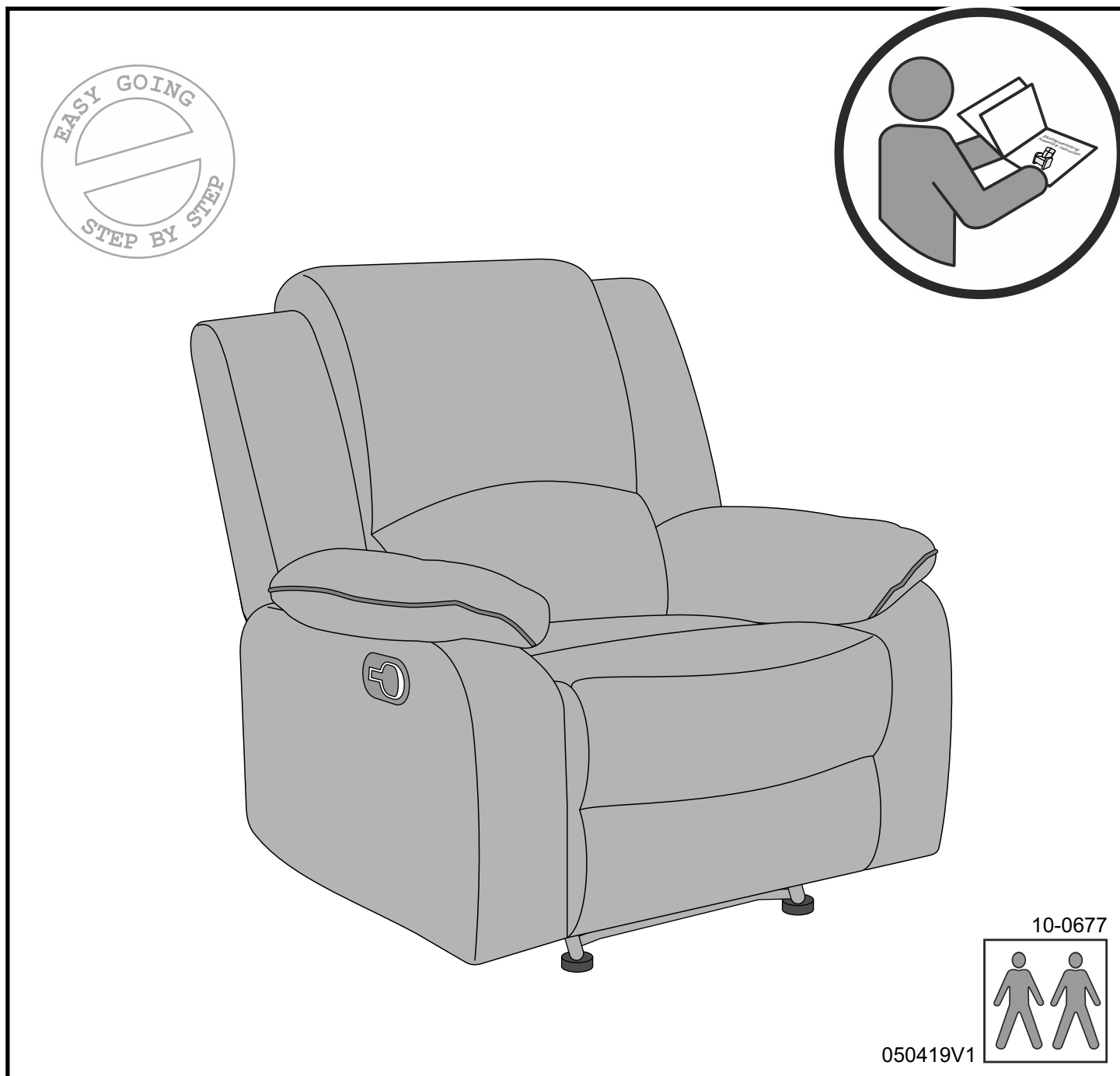

Änderungen die der technischen Verbesserung dienen, behalten wir uns vor.

Subject to changes in the interests of technical improvements.

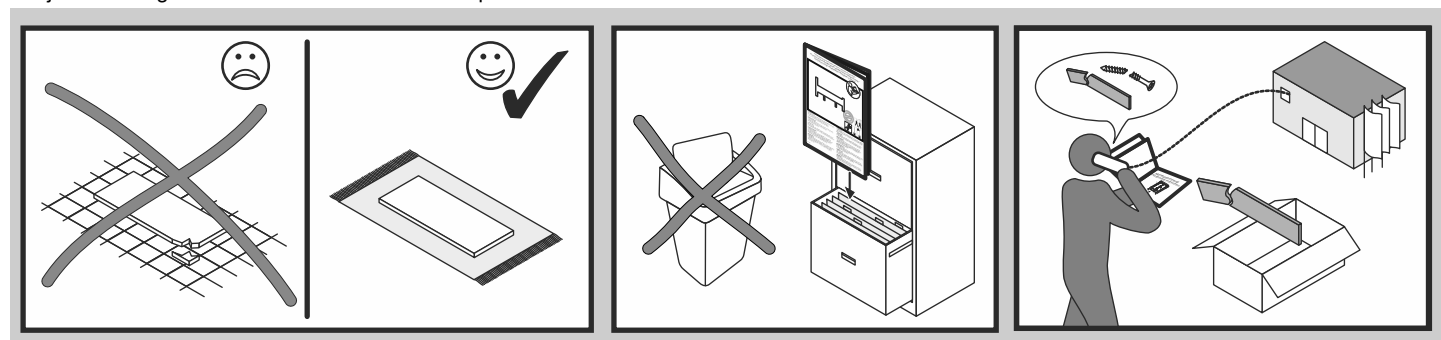

Colli

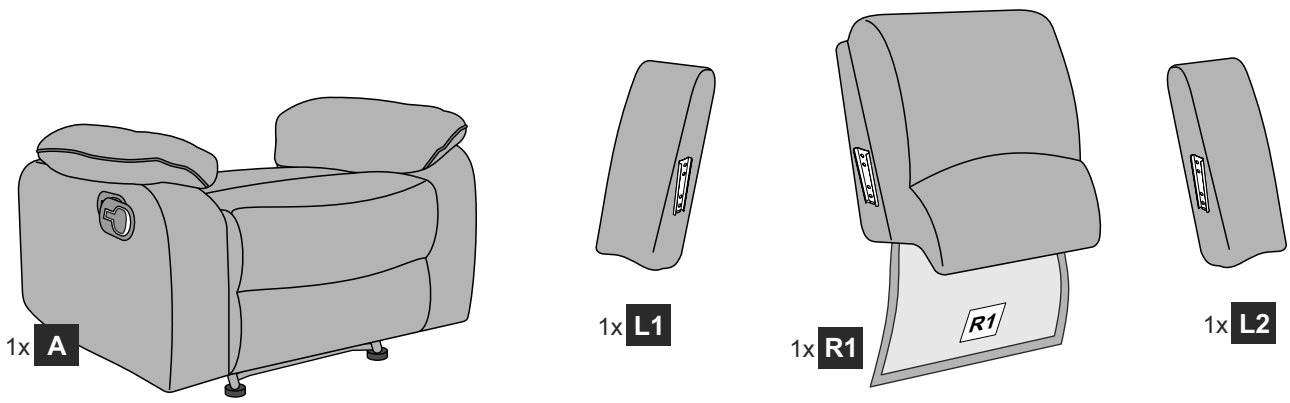

1.

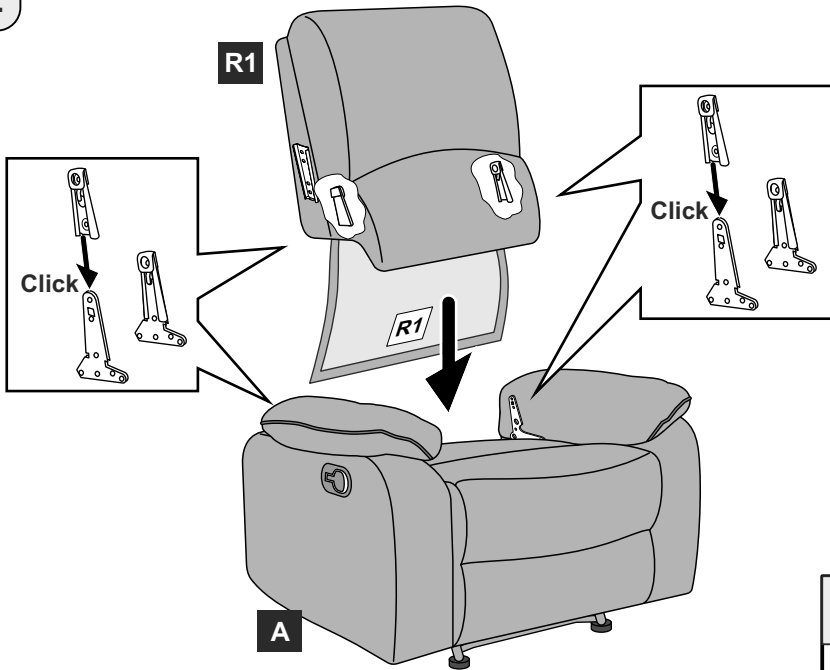

2.

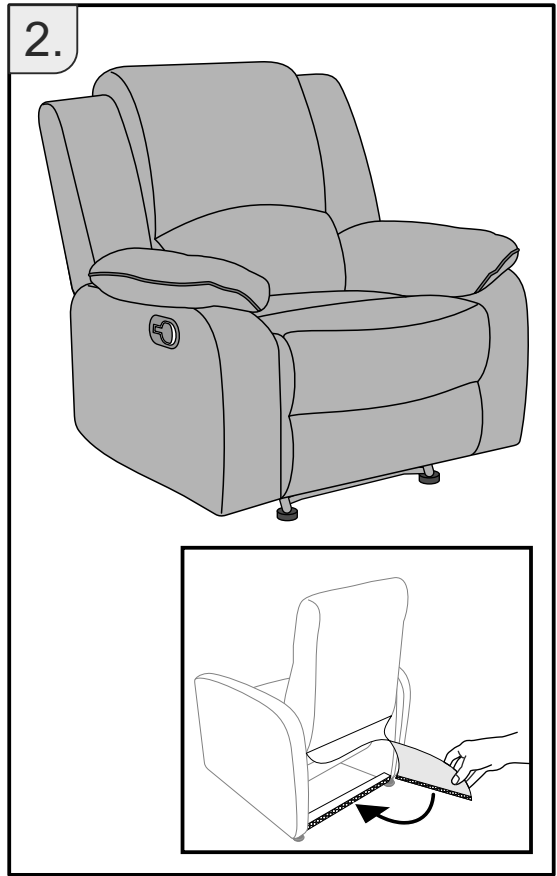
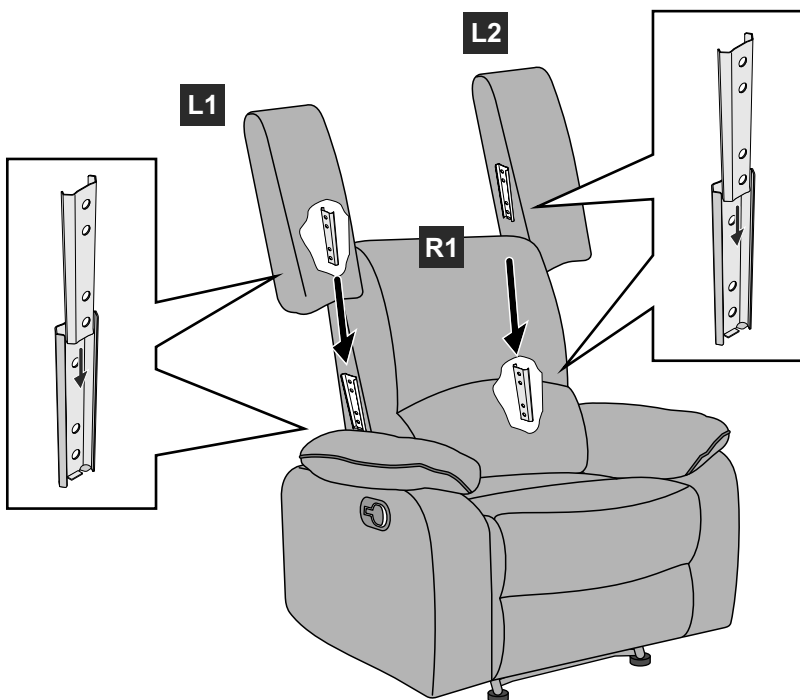

3.

