

# P185 / P208

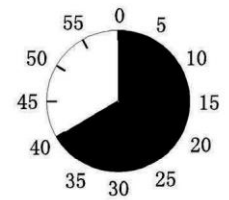

1

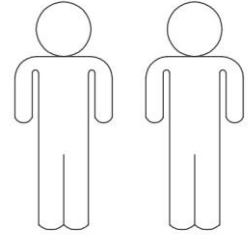
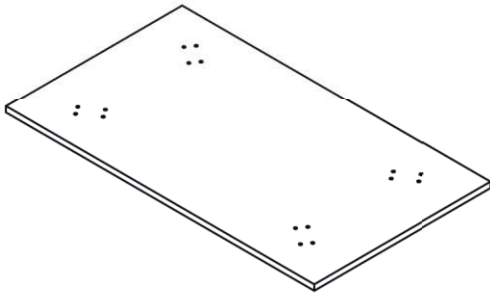

2.1



2.2

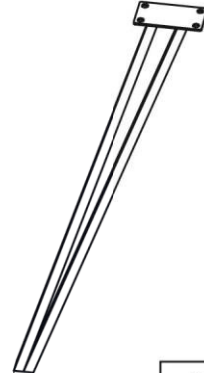



1	1x	1/2
2	4x	2/2

<p><b>A</b> M8*12                    16X</p>	<p><b>B</b> M8*16                    16X</p>	<p><b>C</b> Ø18*Ø8*1.5                    16X</p>	<p><b>D</b> Ø25                    4X</p>	<p><b>E</b> 5mm                    1X</p>
<p><b>F</b> 8mm                    1X</p>				

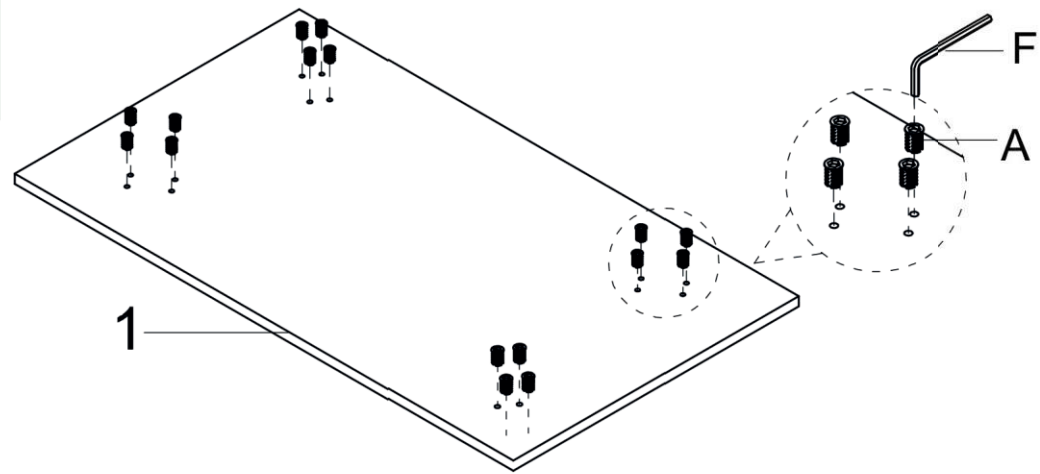



1.  
1.

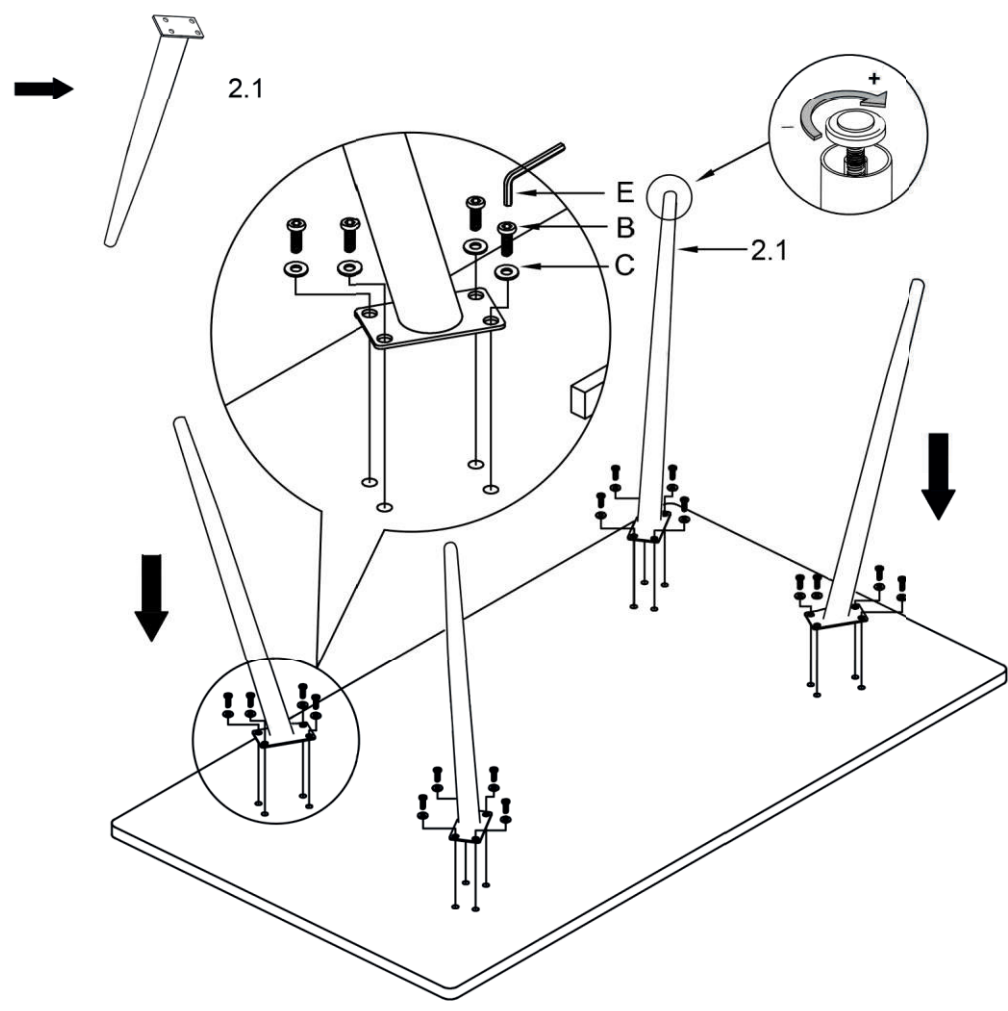

- A  M8\*12  
16X
- F  8mm  
1X
- 

2.1



- B  M8\*16  
16X
- C  Ø18\*Ø8\*1.5  
16X
- E  5mm  
1X
- 

1.  
2.2

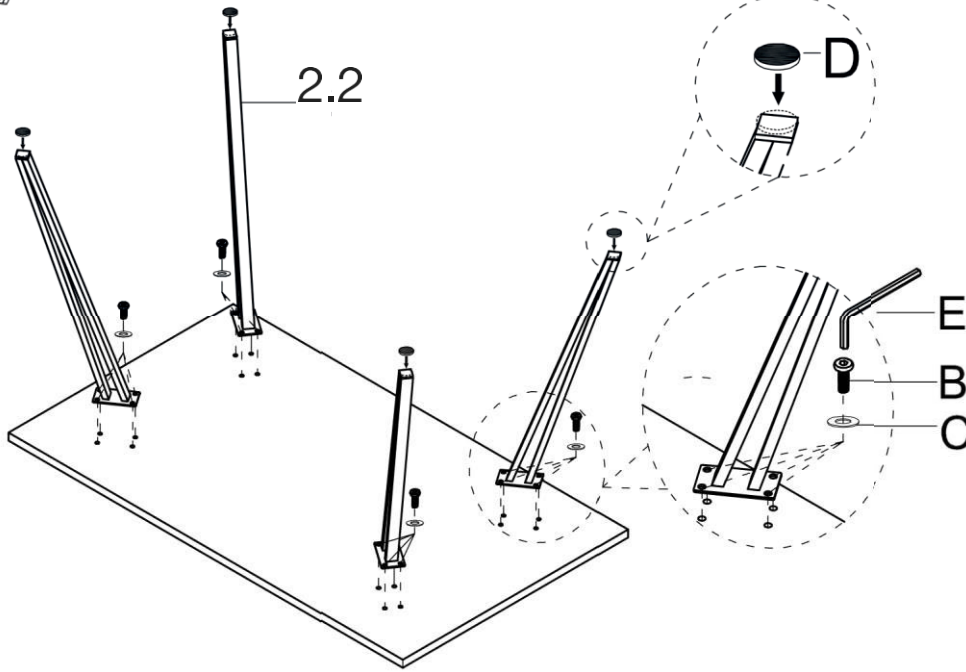

B	M8*16 16X
C	Ø18*Ø8*1.5 16X
D	Ø25 4X
E	5mm 1X

3.

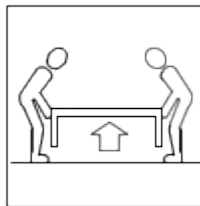
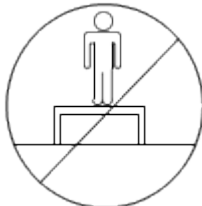
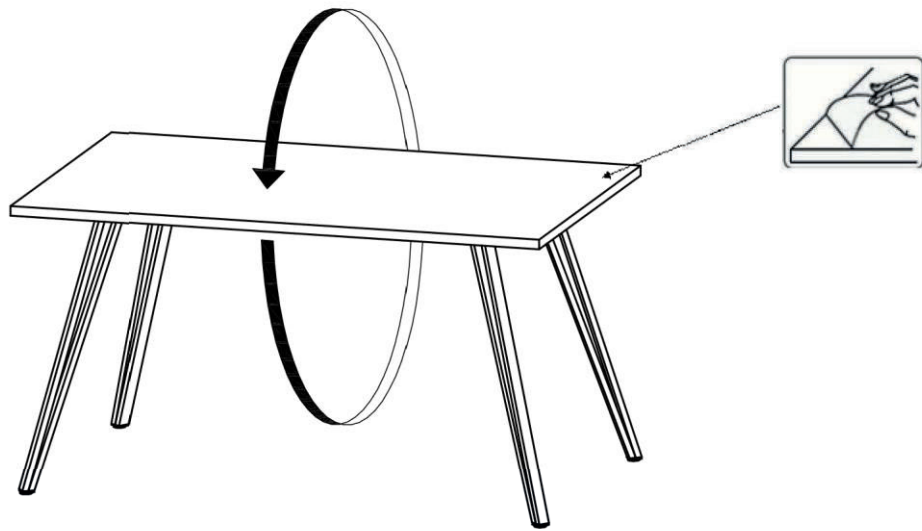
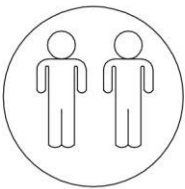

LE TRI  
+ FACILE



BAC  
DE  
TRI

Séparez les éléments avant de trier