

# P185 / P208

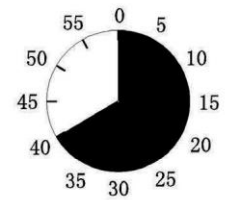

1

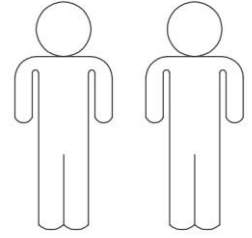

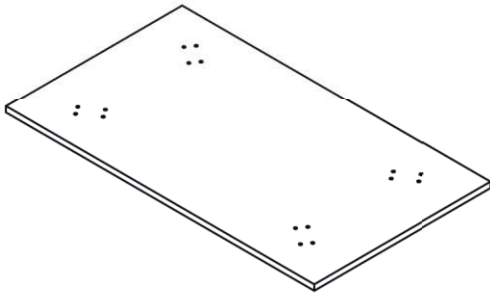



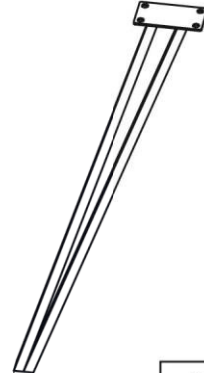

2.1



2.2



		
1	1x	1/2
2	4x	2/2

<p><b>A</b> M8*12                    16X</p>	<p><b>B</b> M8*16                    16X</p>	<p><b>C</b> Ø18*Ø8*1.5                    16X</p>	<p><b>D</b> Ø25                    4X</p>	<p><b>E</b> 5mm                    1X</p>
<p><b>F</b> 8mm                    1X</p>				

1.  
1.

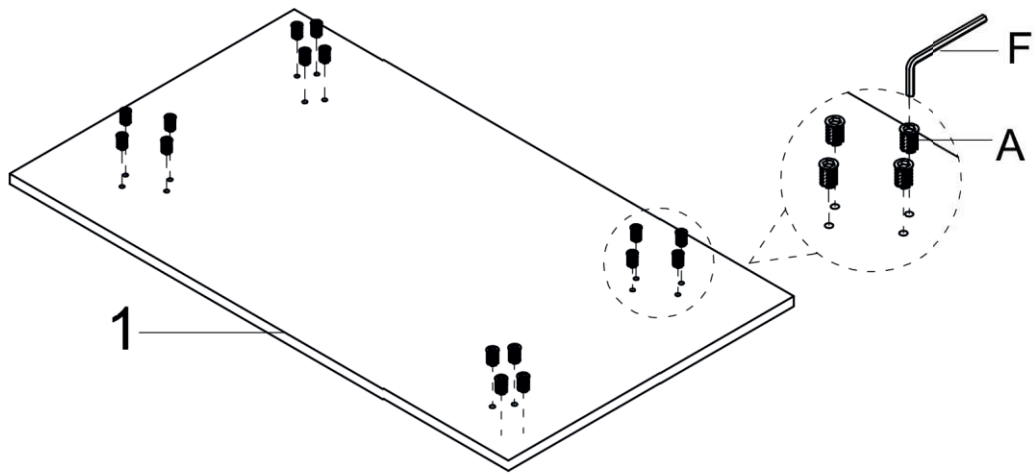

- A M8\*12 16X
- F 8mm 1X
- 100%

2.1

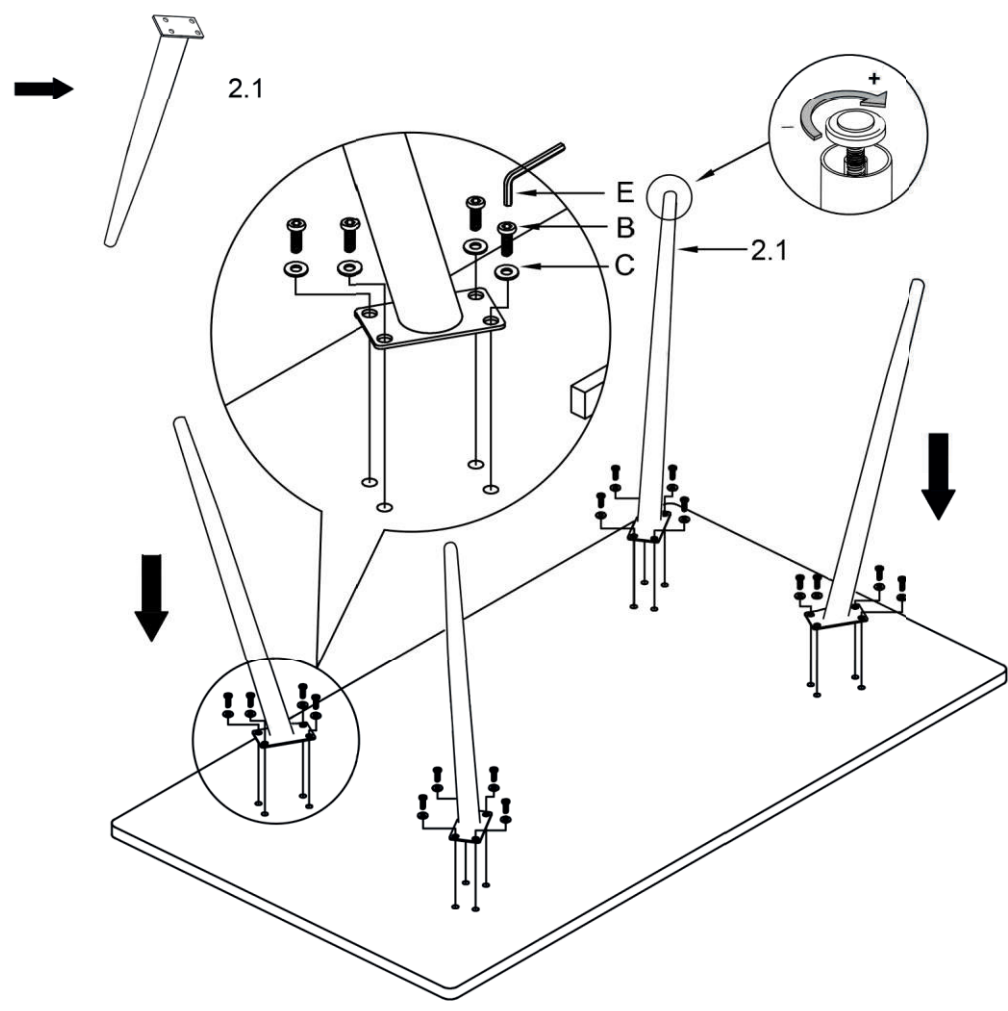

- B M8\*16 16X
- C Ø18\*Ø8\*1.5 16X
- E 5mm 1X
- 100%

1.  
2.2

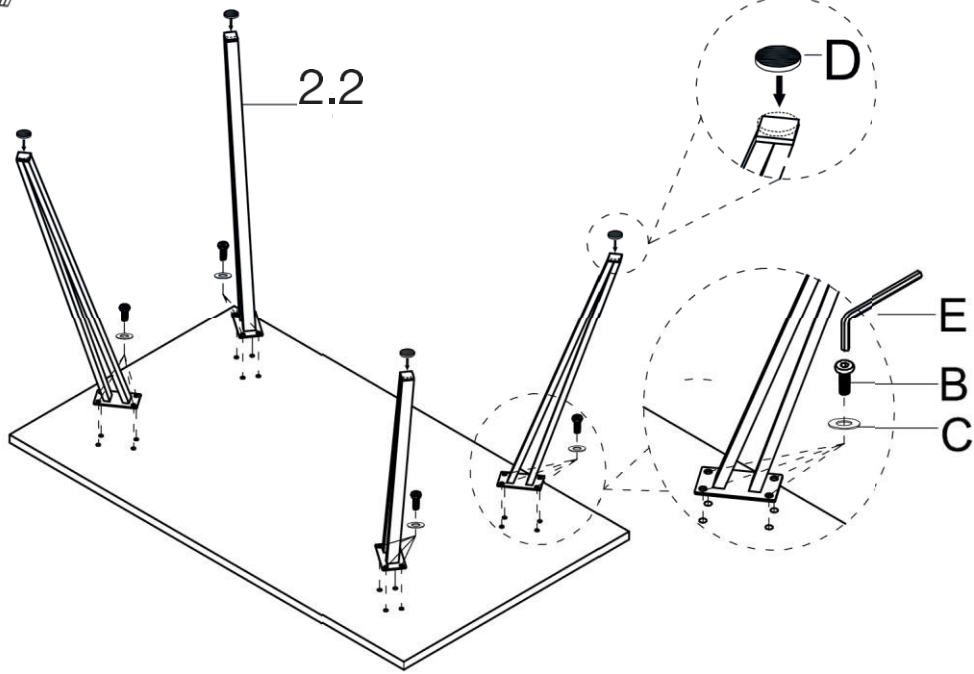
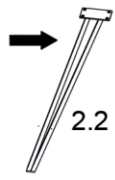

B	M8*16 16X
C	Ø18*Ø8*1.5 16X
D	Ø25 4X
E	5mm 1X

3.

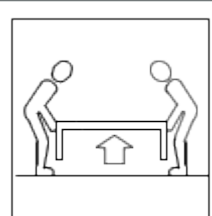
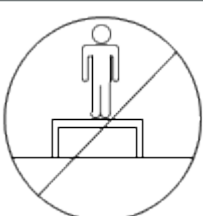
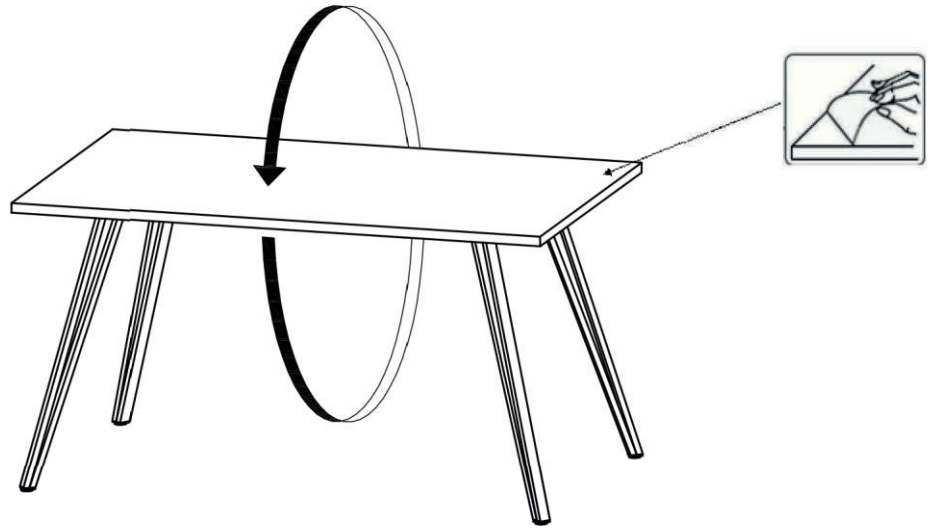
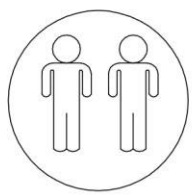

**LE TRI + FACILE**

Séparez les éléments avant de trier