

134502170...
2427020.../37
2427019.../37
5107445
5107446
5107118
5107447

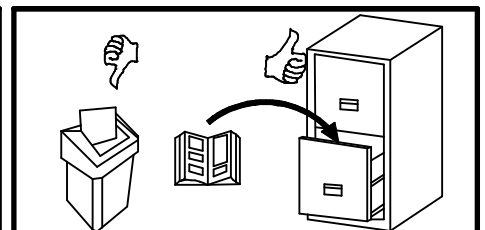

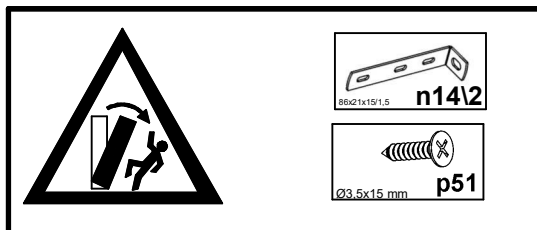

A	B1	B2	C1	C2	C3	D
1	S588-0003	-4	1916	396	15	3/3
2	S588-1001	-3	1922	382	15	2/3
3	S588-1002	-4	1922	382	15	2/3
4	S588-2003	-4	800	400	15	1/3
5	S588-3005	-2	769	360	15	1/3
6	S588-3006	-1	769	360	15	1/3
7	S588-9301	-2	1925	779	2,5	2/3
8	S588-3034	-	769	360	15	1/3

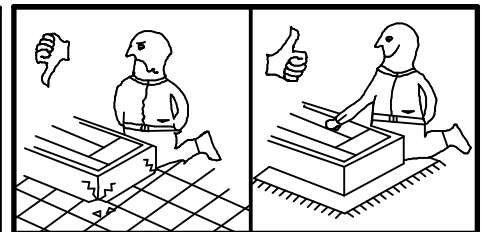
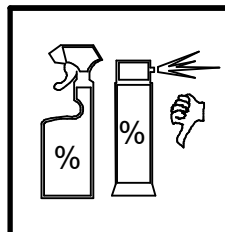
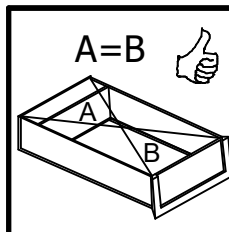
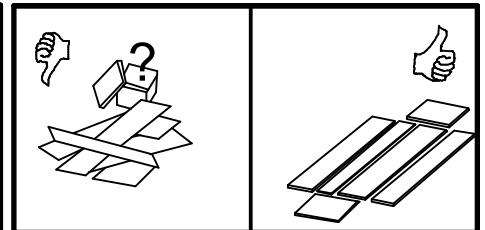
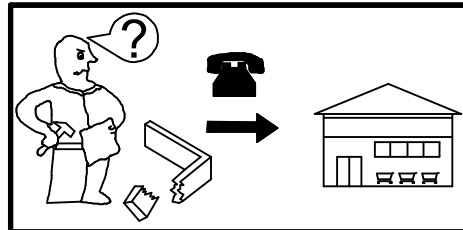
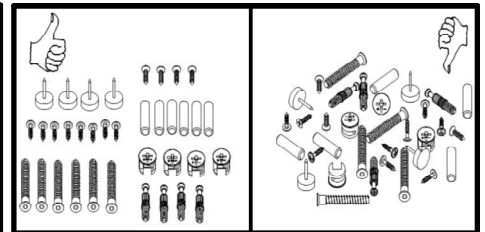
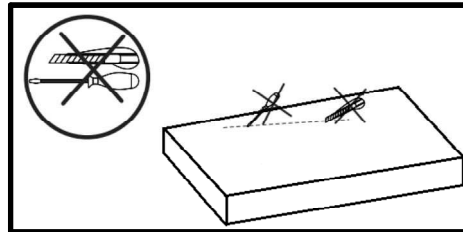
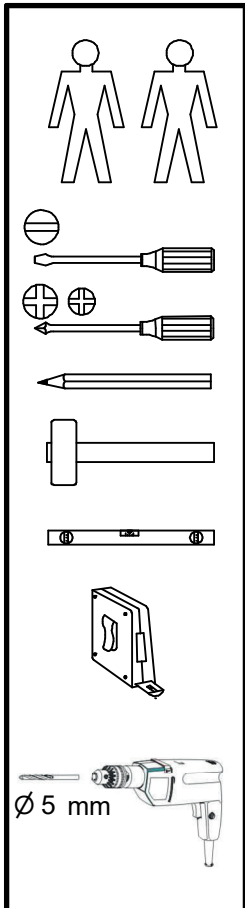
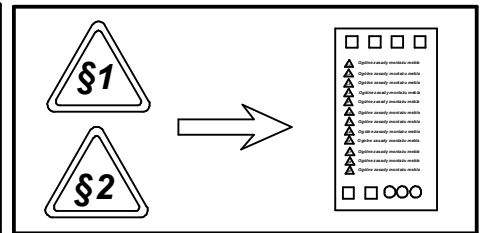
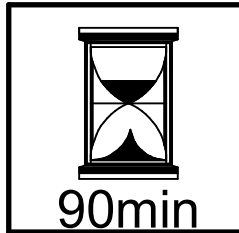
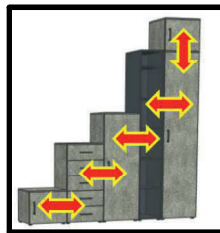
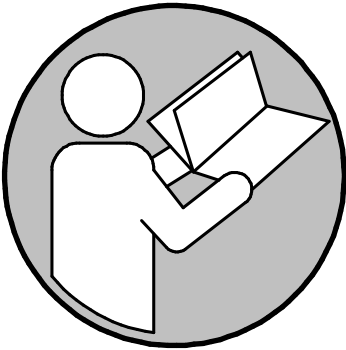
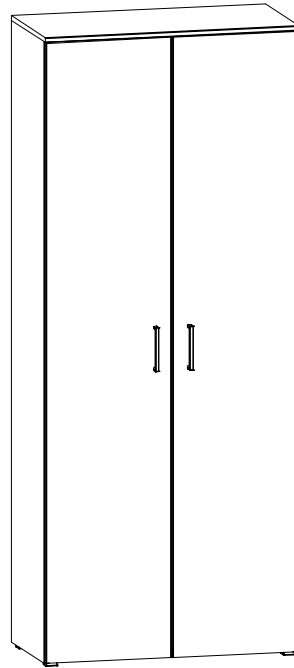
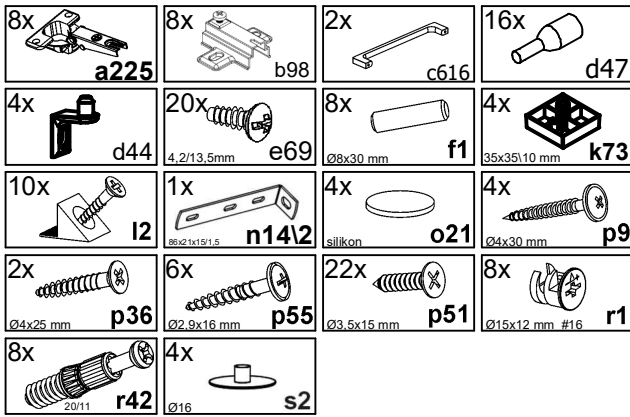
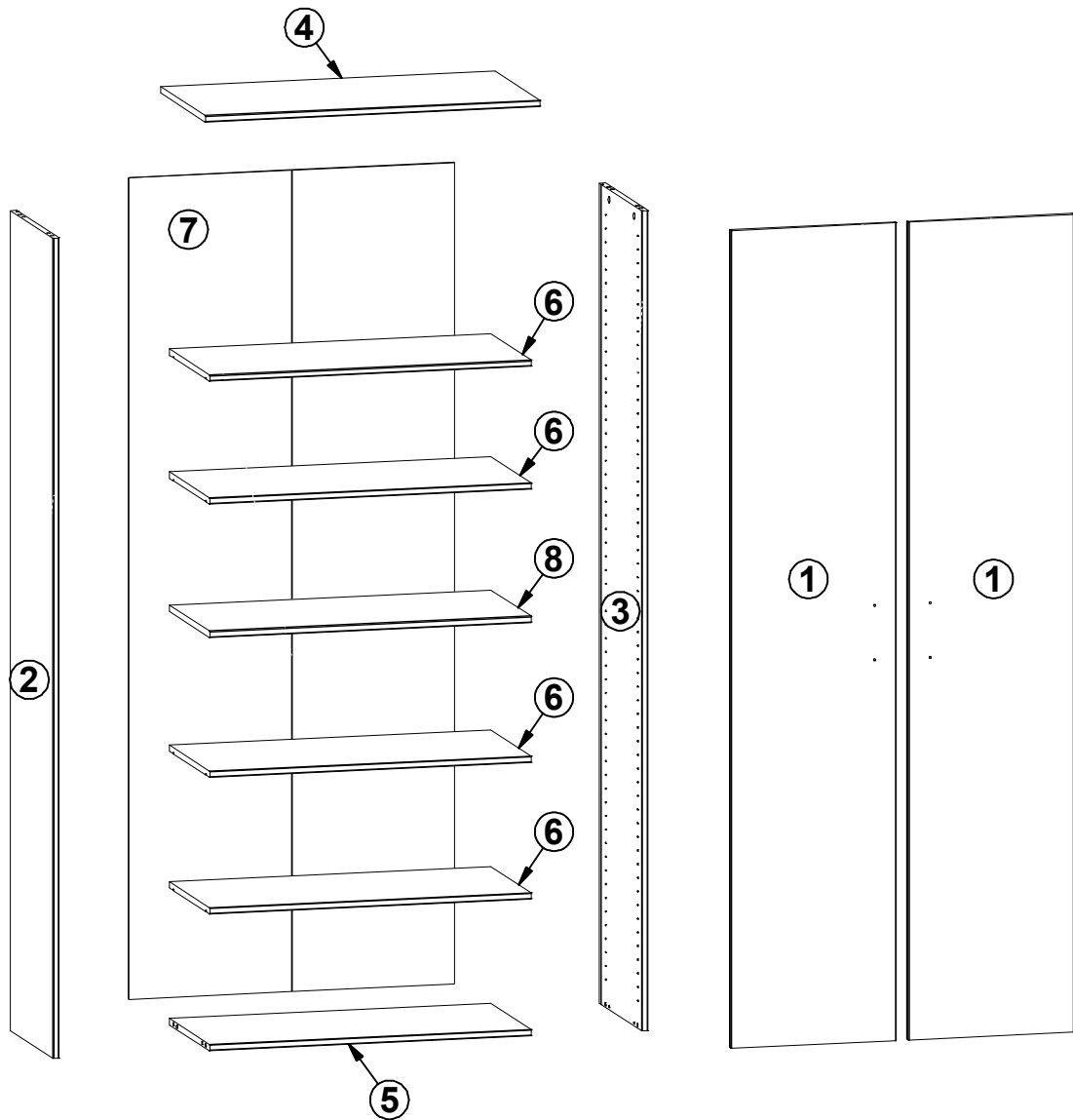

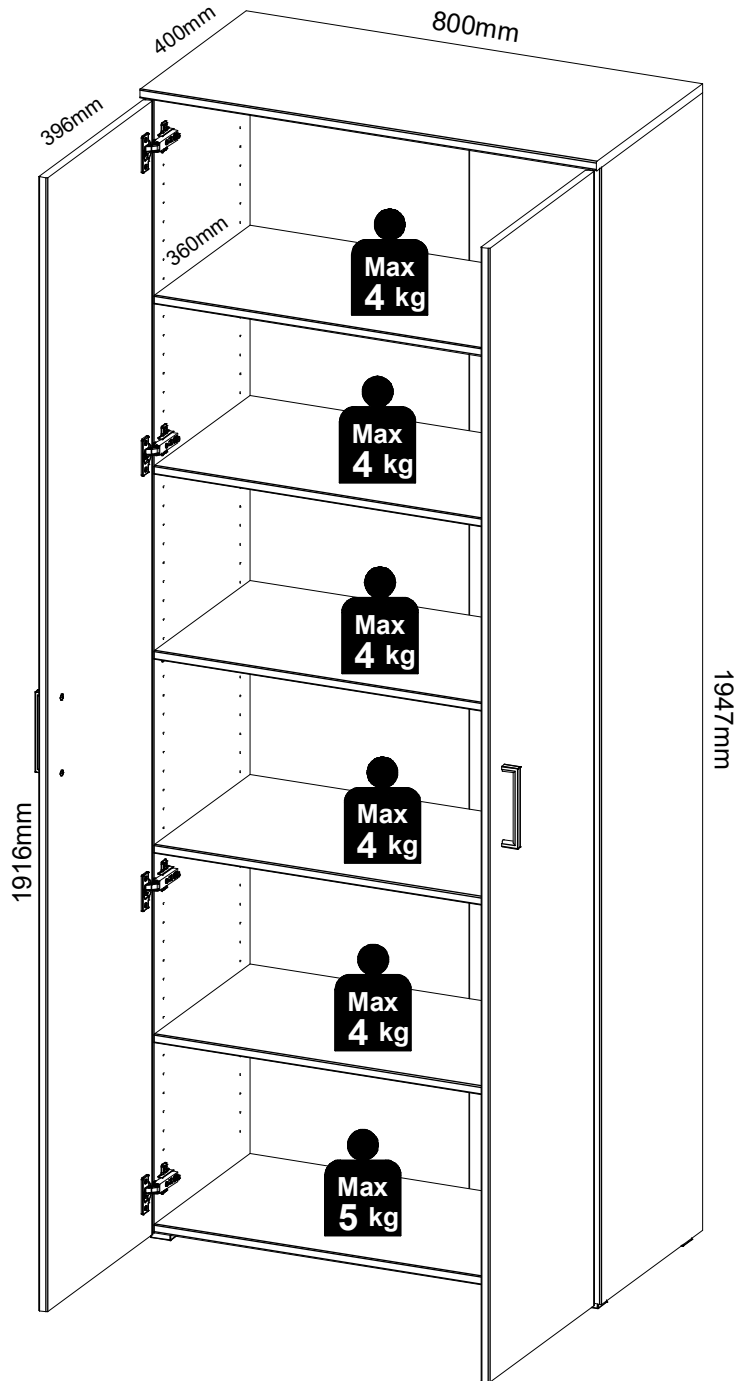

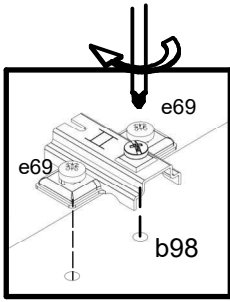
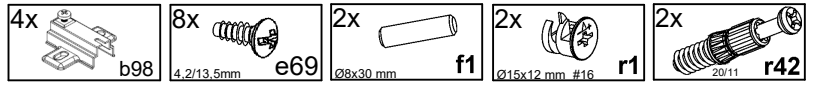

1 ▶

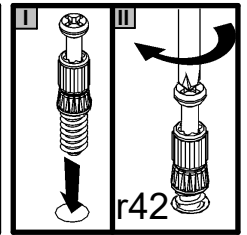
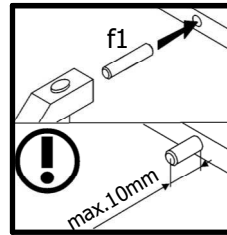
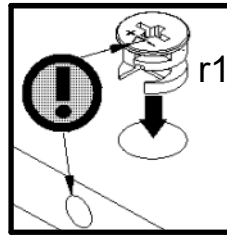
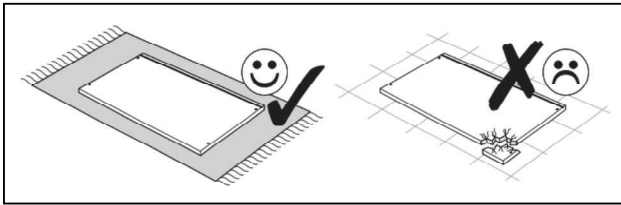
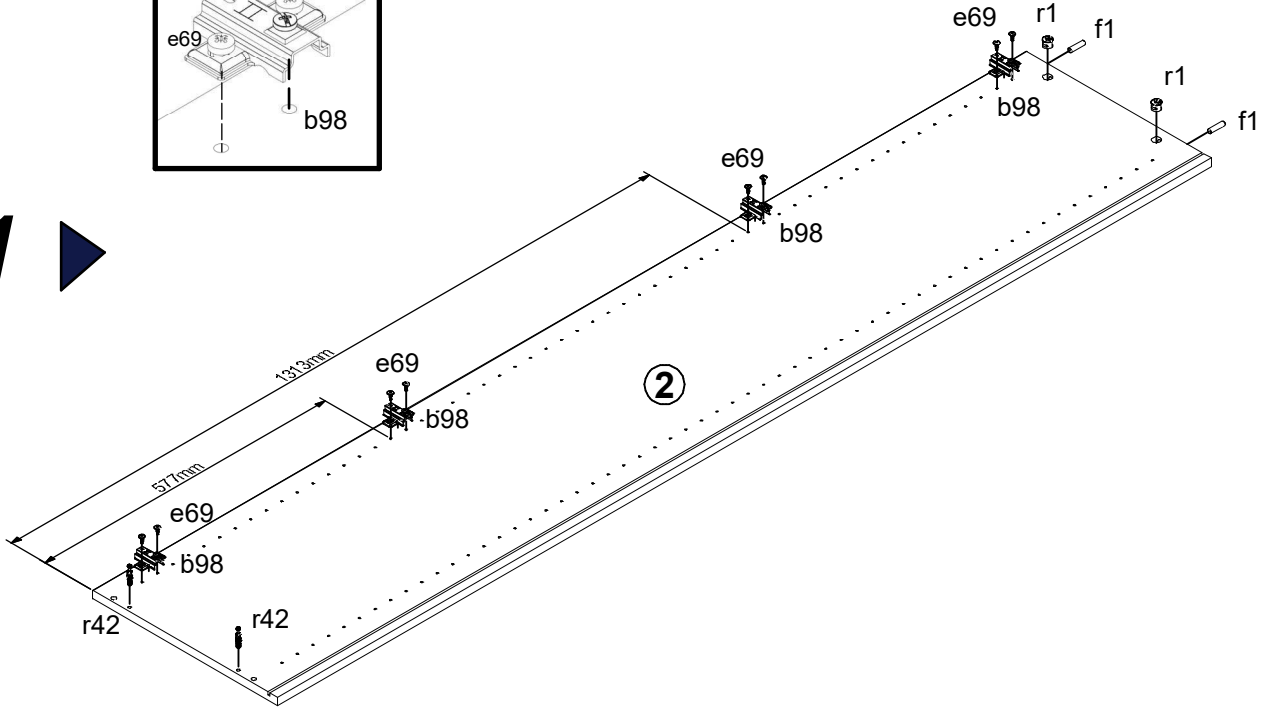

2 ▶

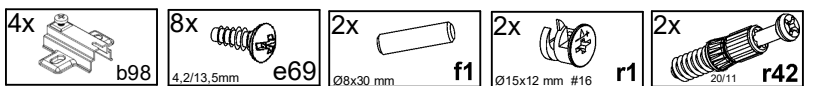
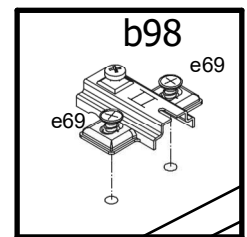
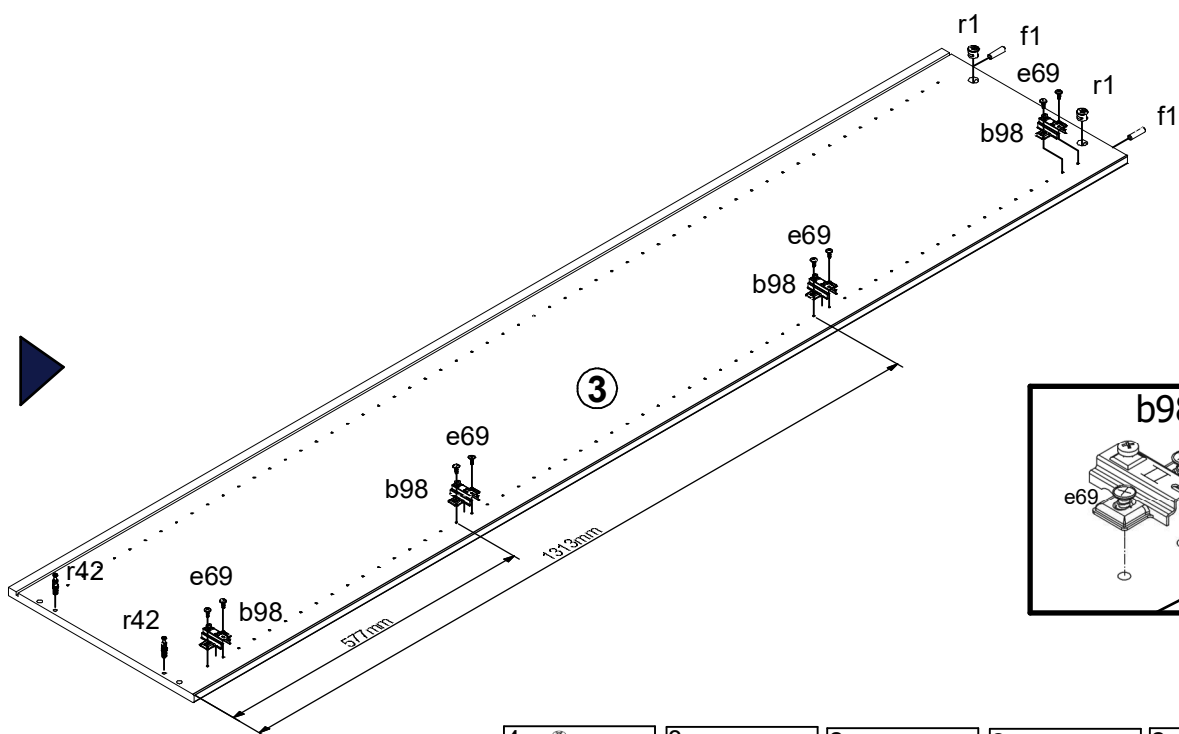

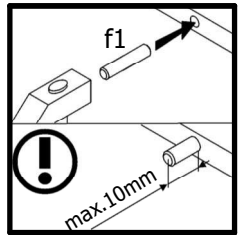
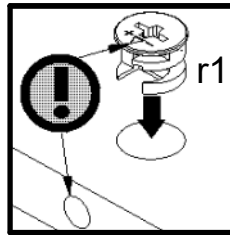
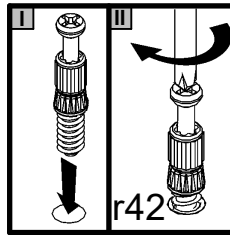
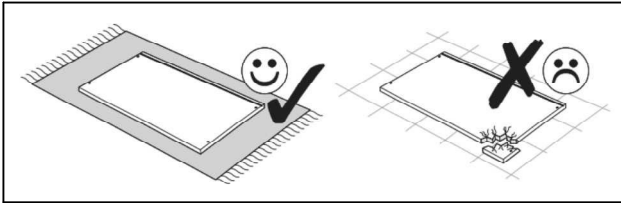
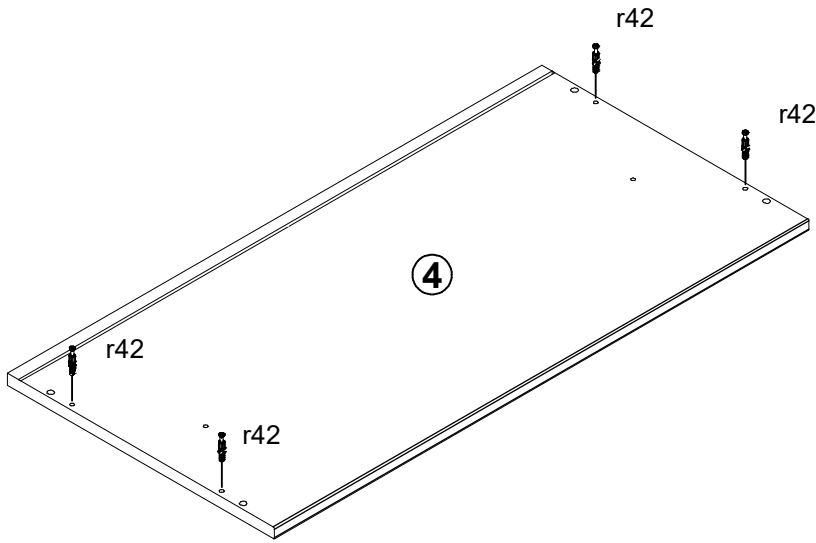
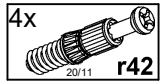

4 ▶

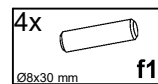
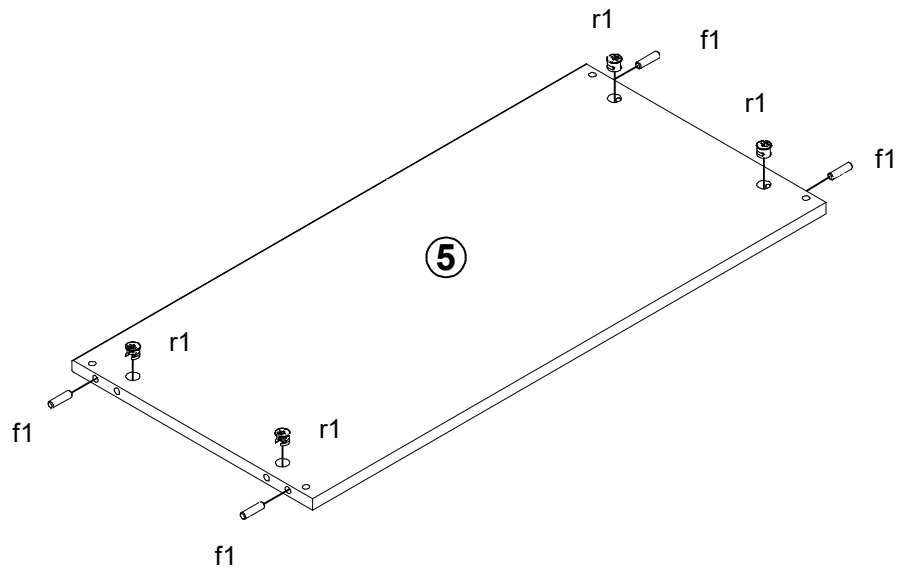

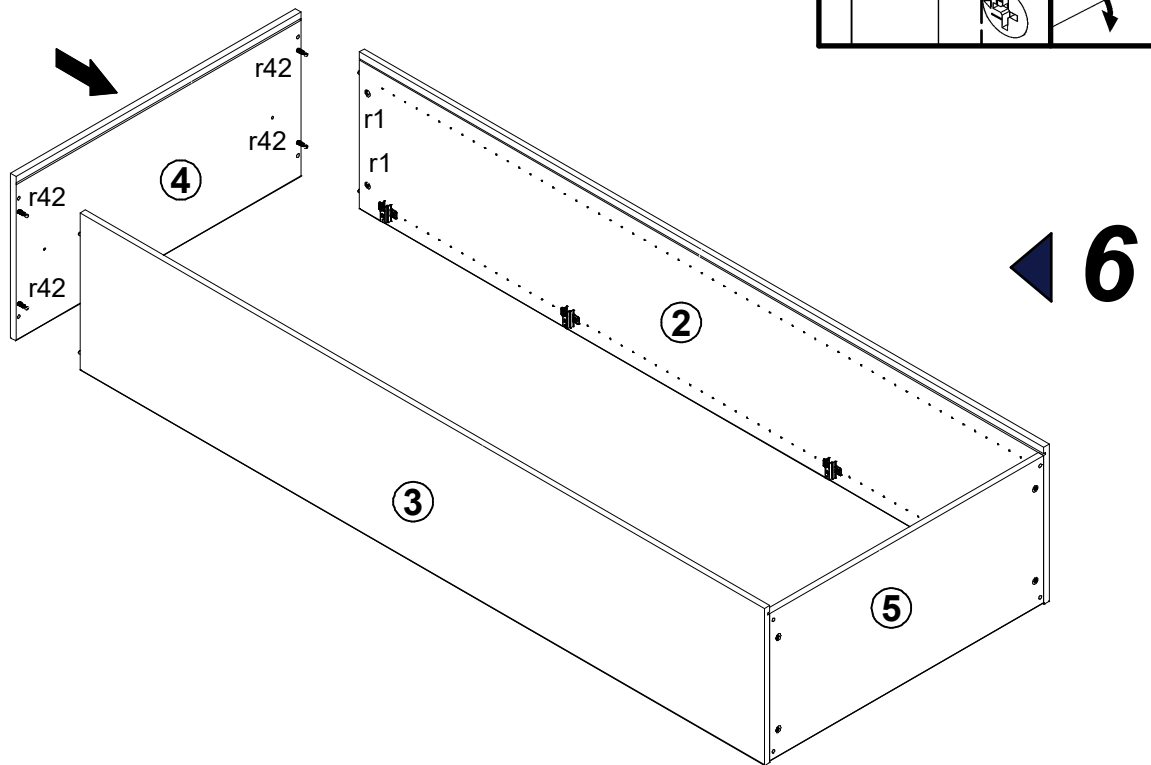
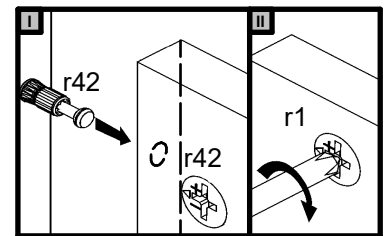
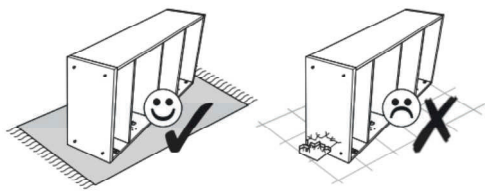
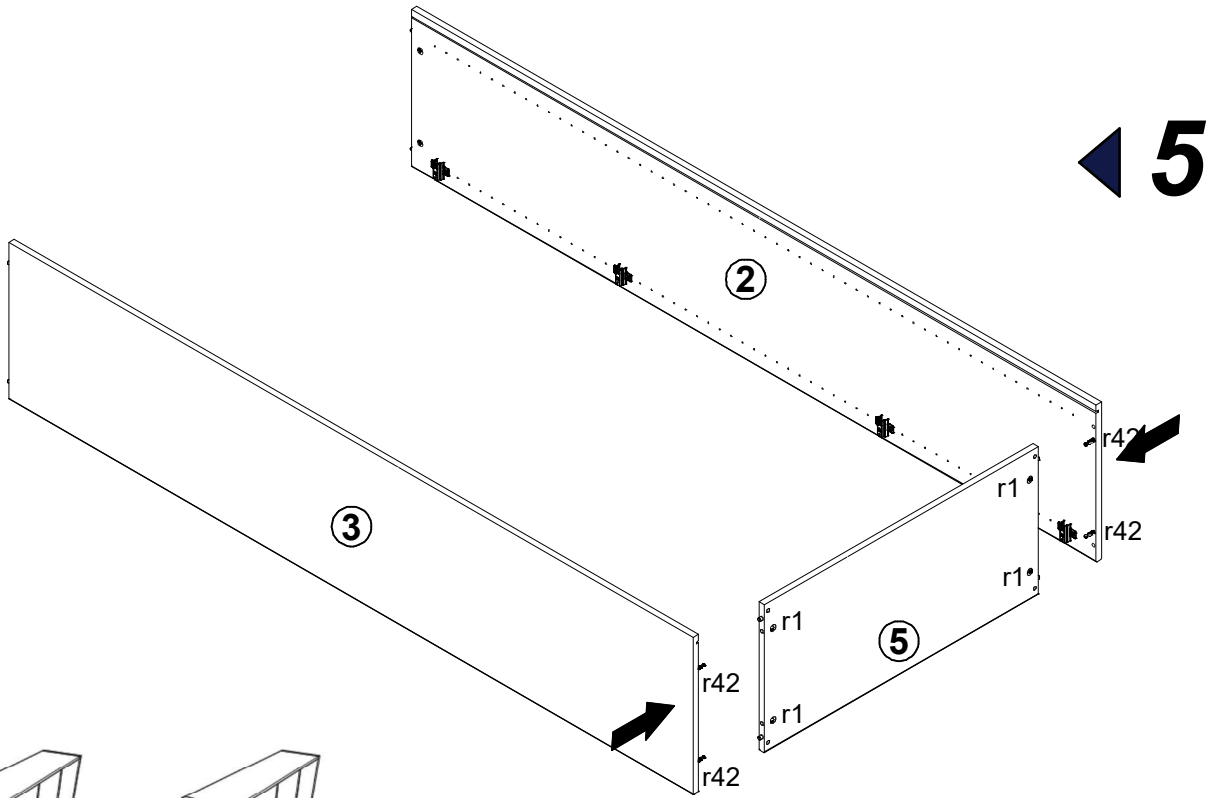

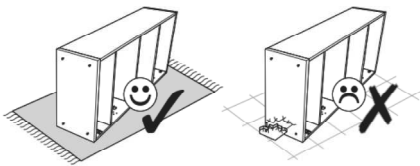
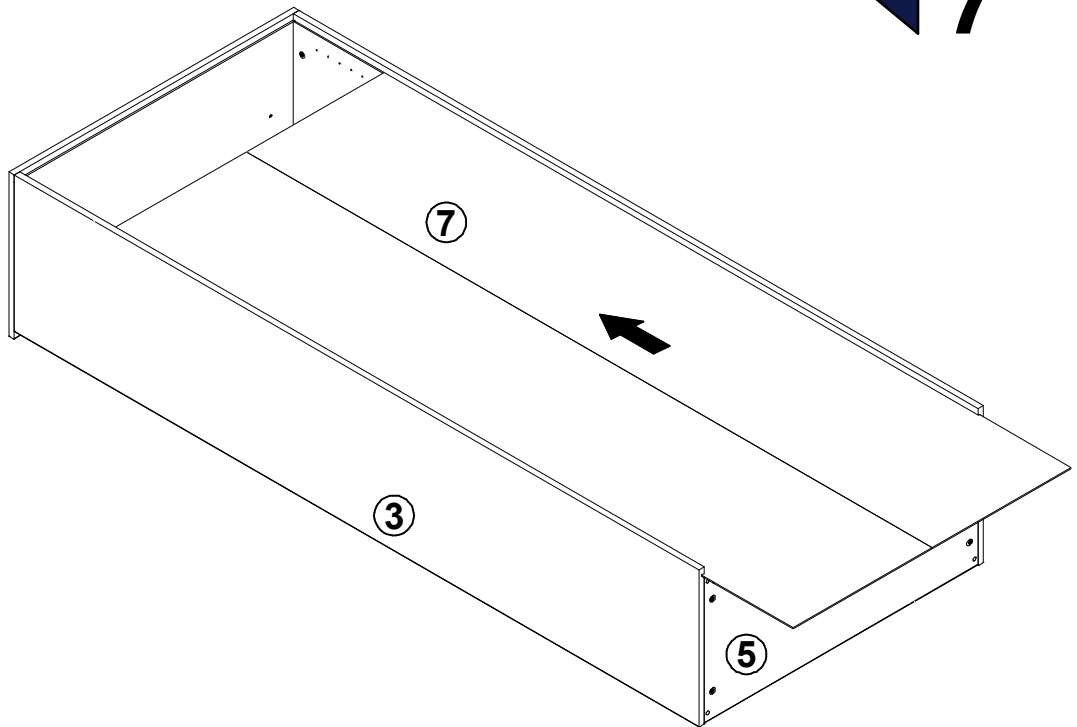

8 ▶

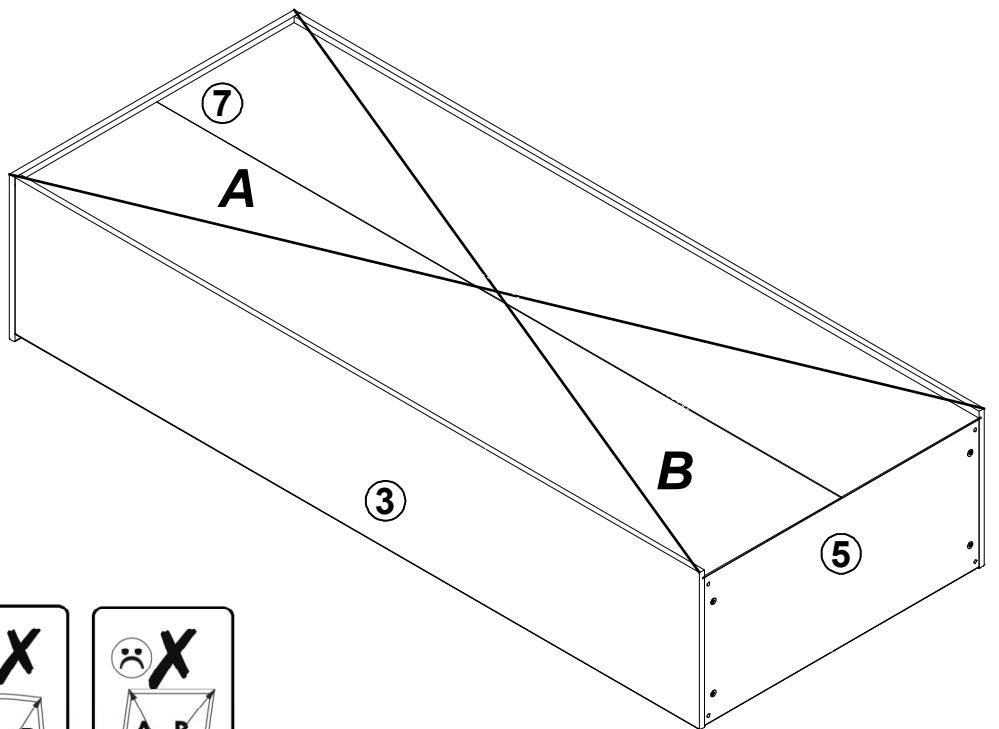

⚠
A=B

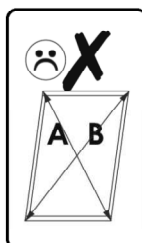
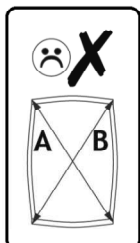
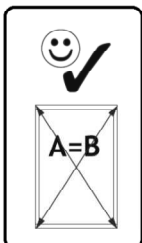

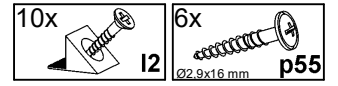

9 ▶

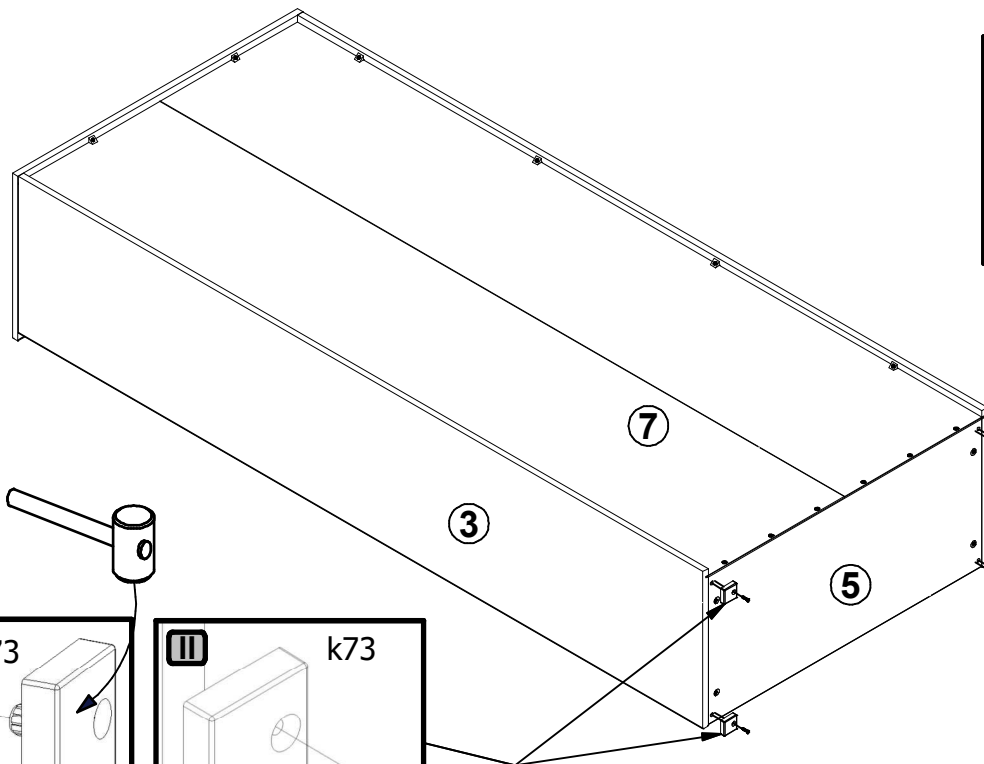
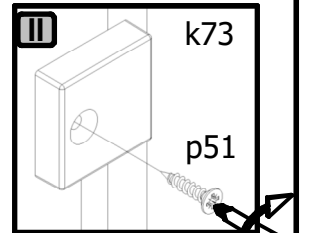
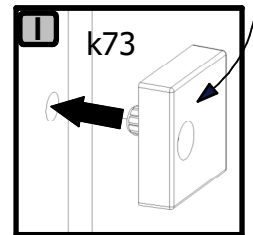
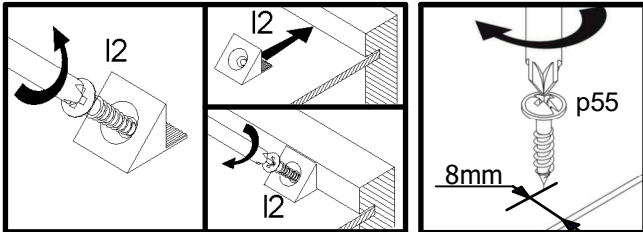
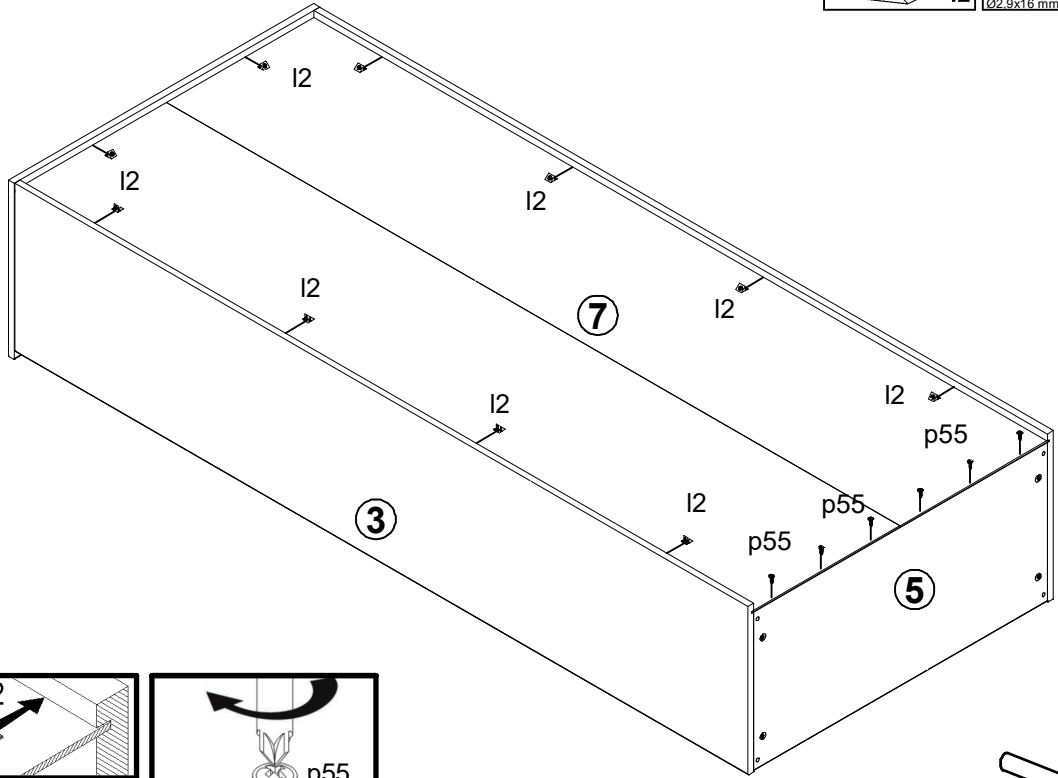

▶ 10

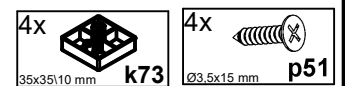
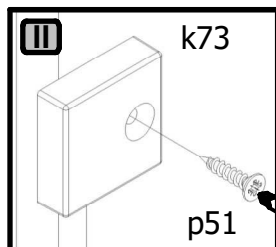
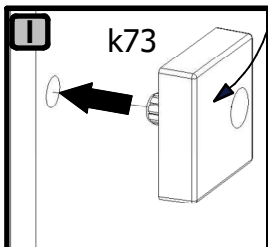

- 4x s2
- 16x d47
- 4x d44
- 4x 4,2/13,5mm e69

11

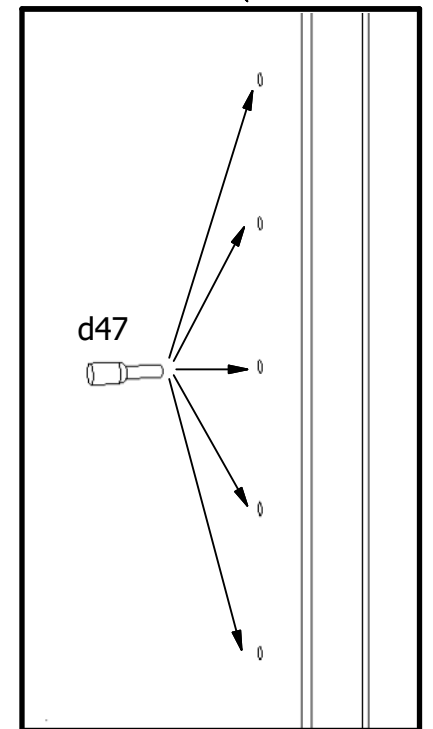
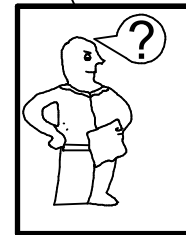
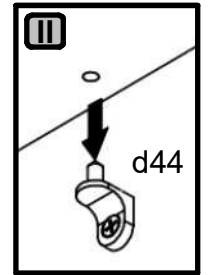
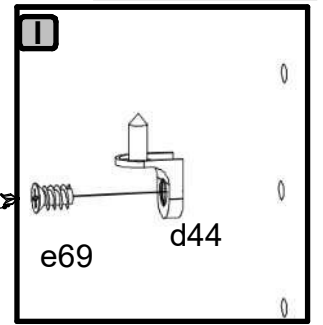
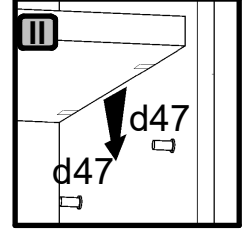
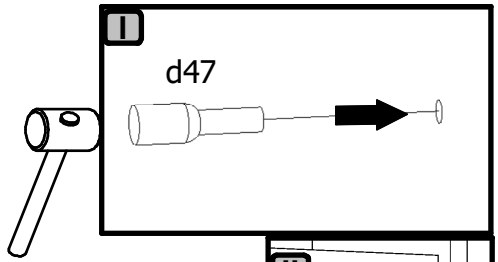
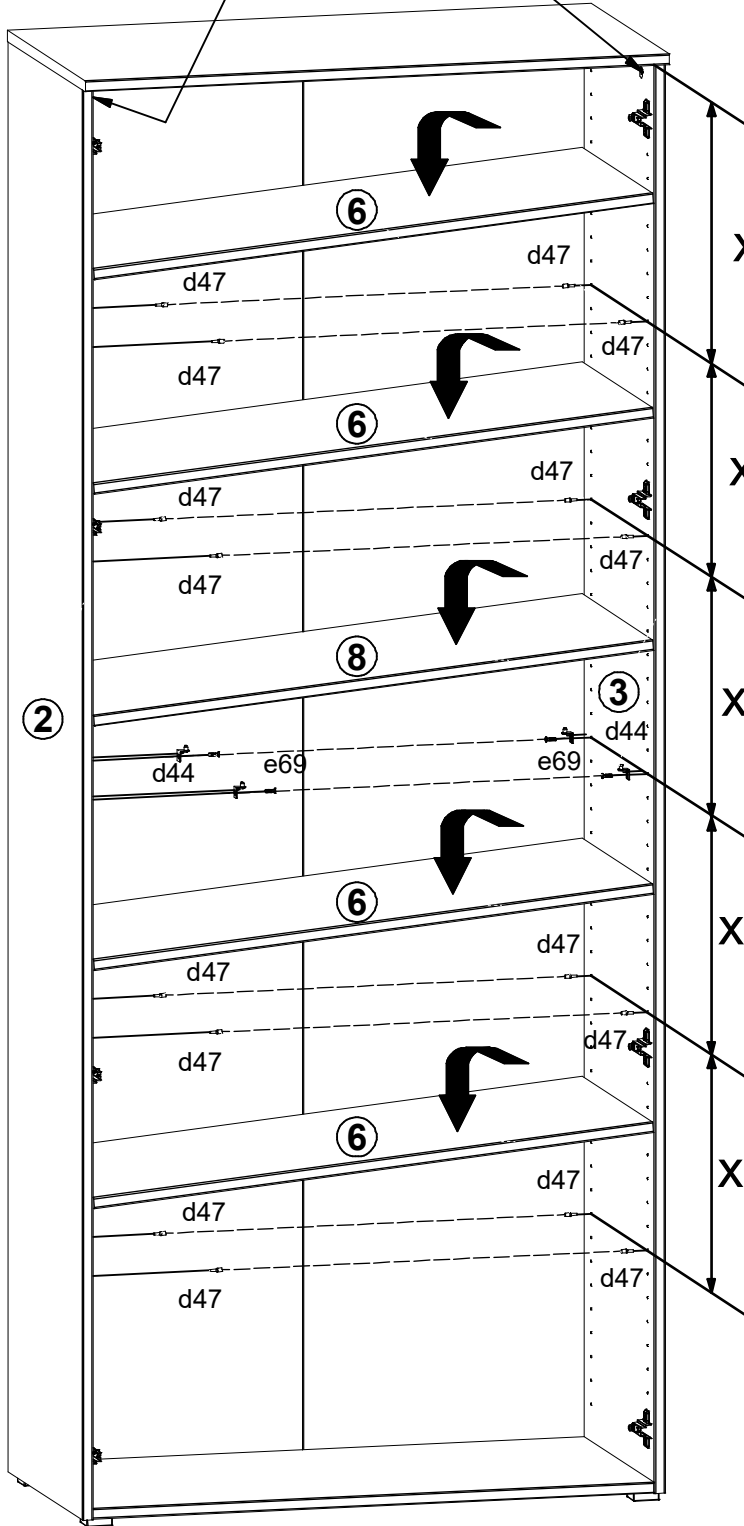
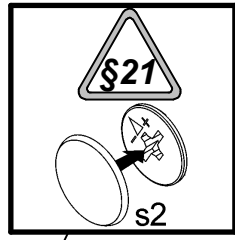

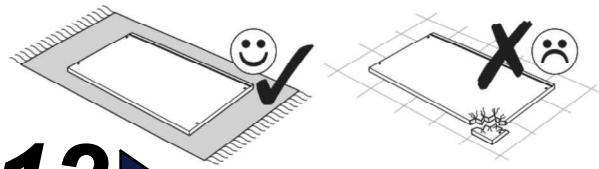

12
2x

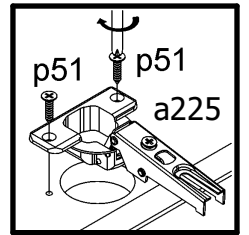
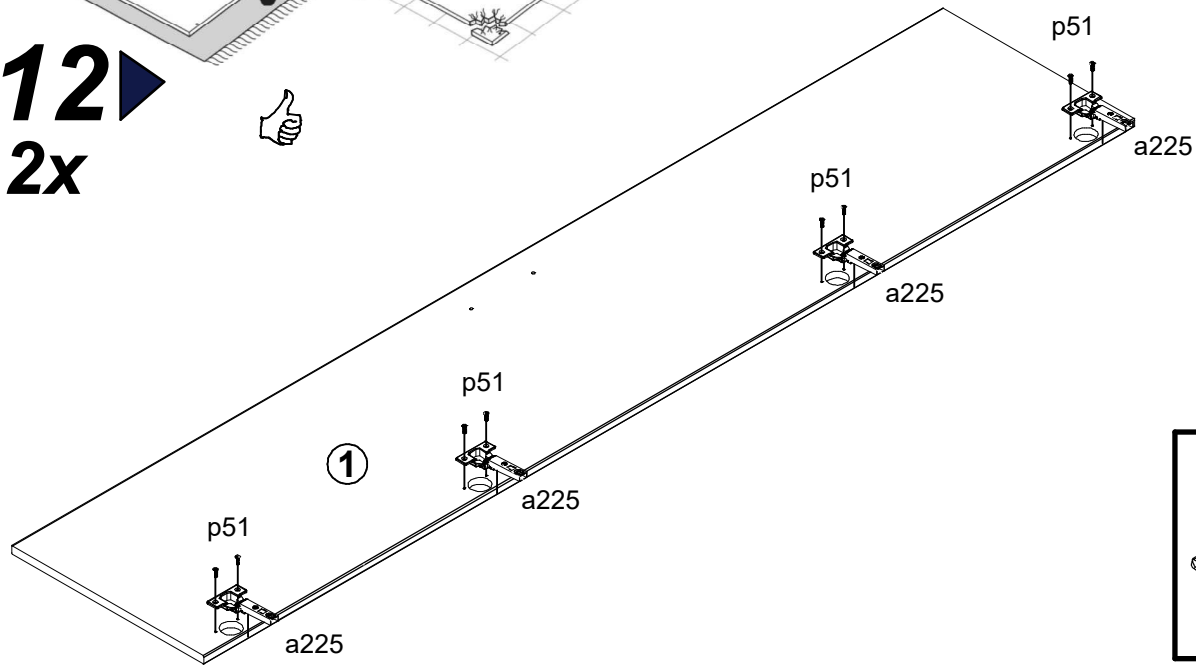
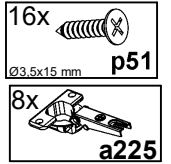

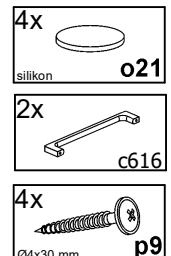
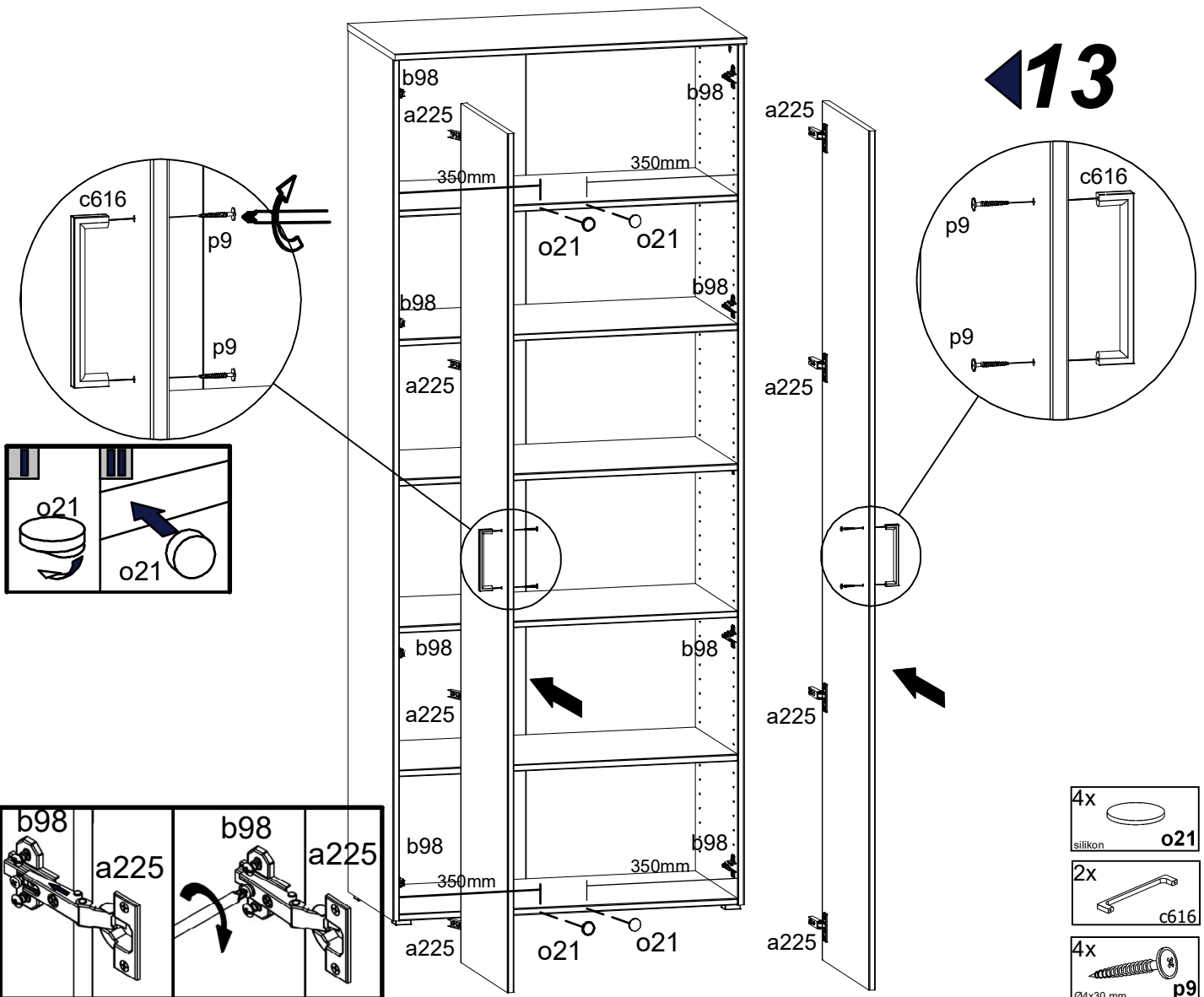

13

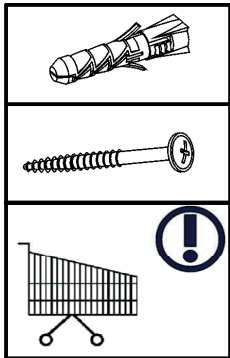
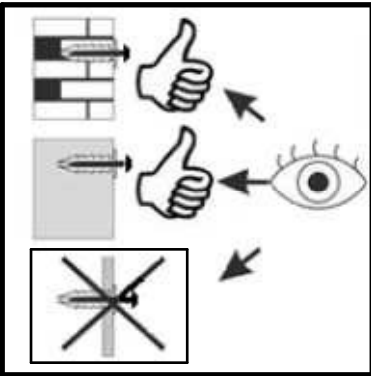
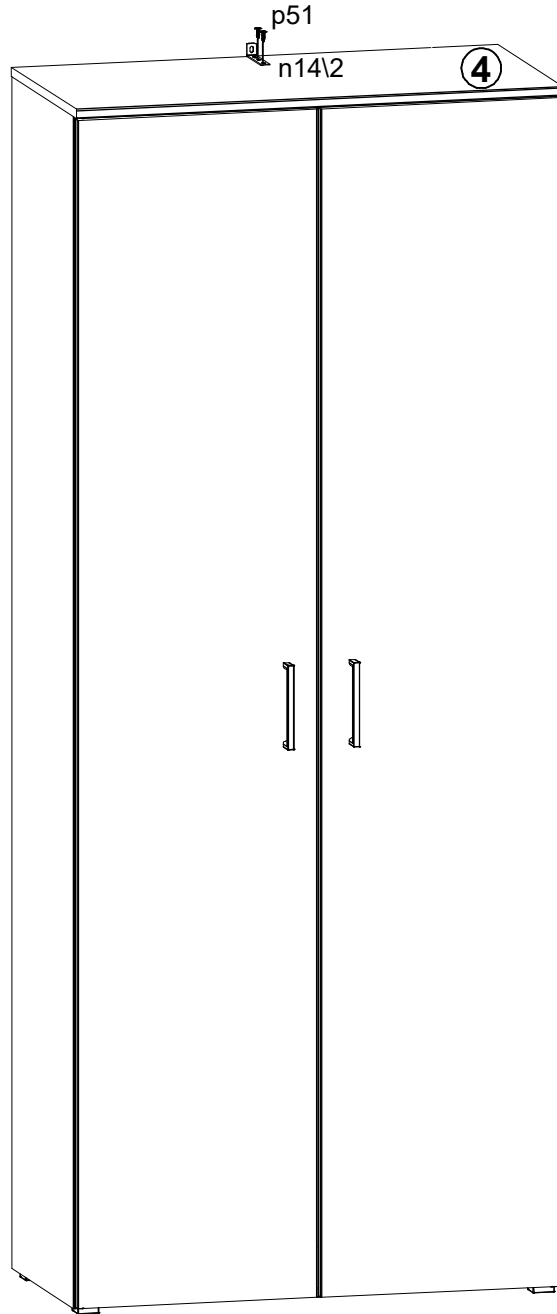
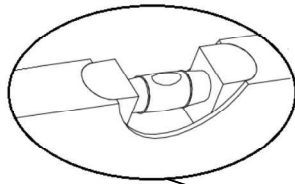
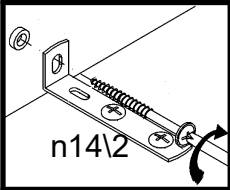
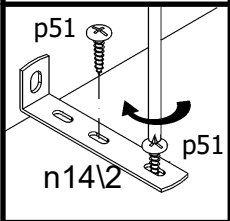
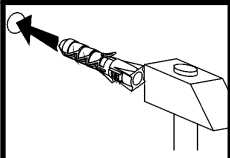
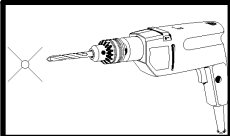

14



2x  p51
Ø3,5x15 mm

1x  n142
88x21x15/1,5

