

A	2	550x285x15
B	1	598x284x15
C	1	598x284x15
D	1	598x60x15
E	2	454x294x15

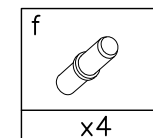

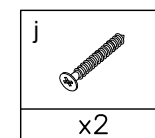

1

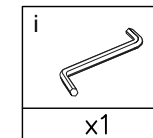
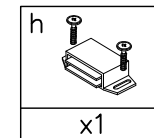
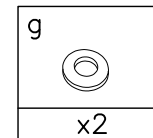
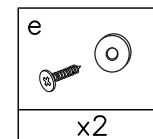
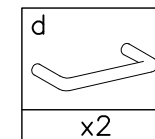
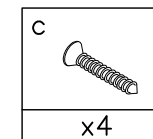
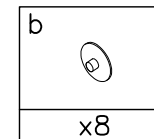
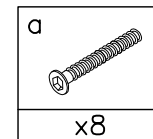
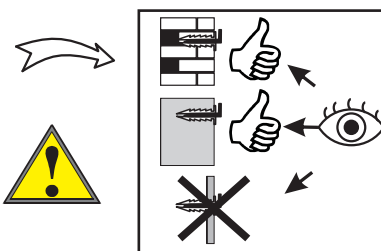
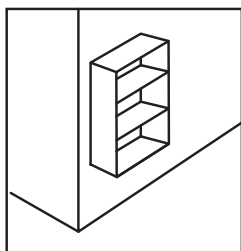
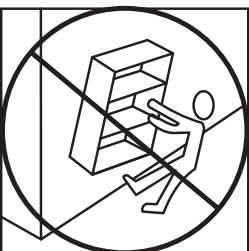
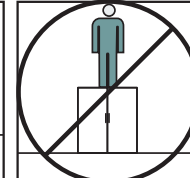
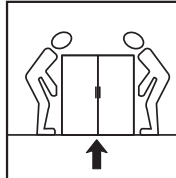
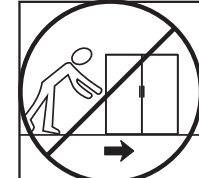
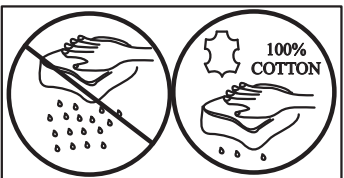
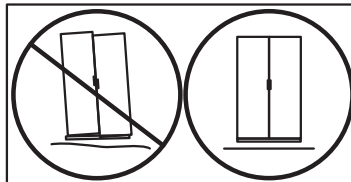
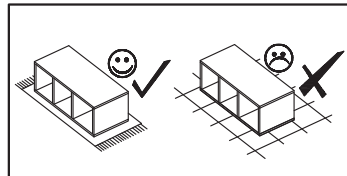
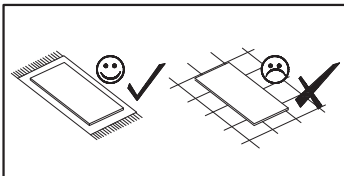
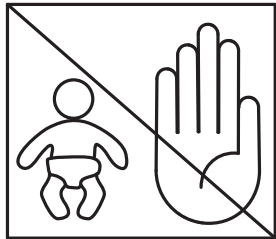
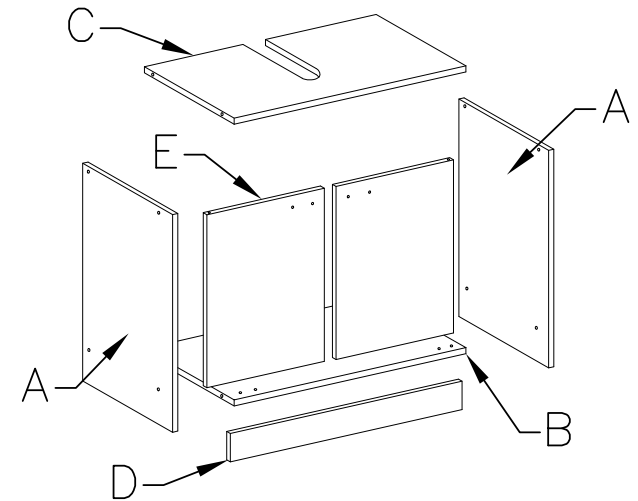
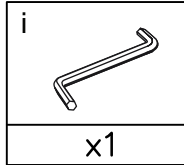
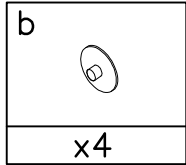
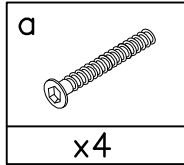
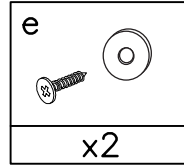
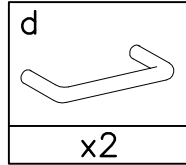
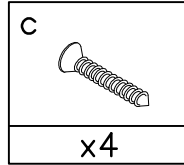
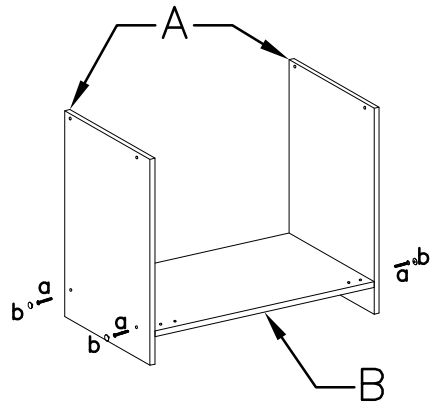

2

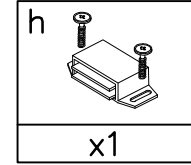
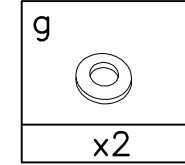
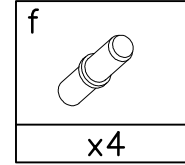
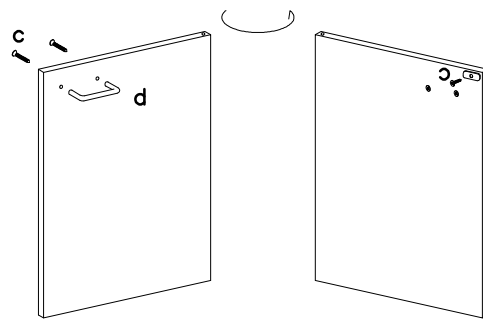

3

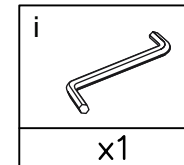
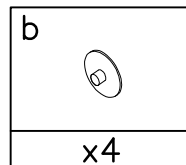
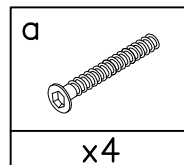
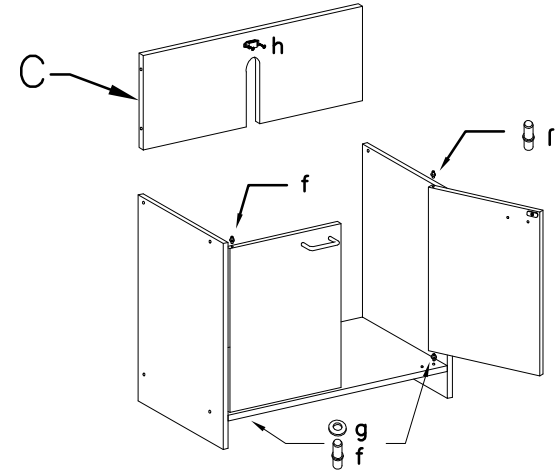

4

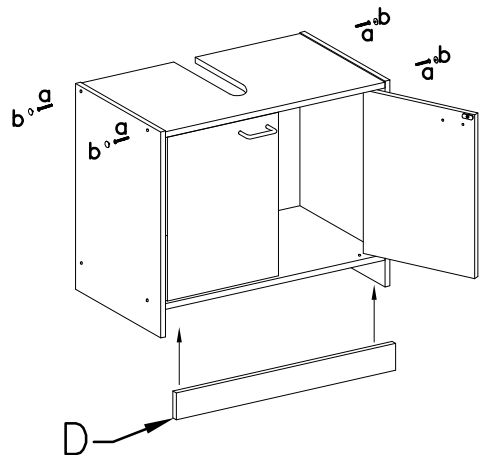

5

